

GReddy AERO KIT

350Z GT Aero Front Bumper

Installation Manual

About this Instruction Manual

IMPORTANT

- ⦿ Please read these instructions before installation.
- ⦿ This is for installation on a stock vehicle.
- ⦿ Please keep this manual as long as you own the product.
- ⦿ This document includes the following notes:

 **Warning** Serious injury or life threatening situations can occur if the warning is disregarded.

 **Note** Installation should be done by professionals.

Before Mounting

Important Please be sure to read.

- ⦿ This product is for off-road use only.
- ⦿ Installation and painting should be done by professional paint shops only.
 - Mounting painted products requires special tools and professional experience.
- ⦿ During the mounting process, modifications may need to be made to the vehicle body.
 - During modifications, please exercise proper safety.
- ⦿ Please do all vehicle inspections and maintenance before attempting installation.
 - Please confirm below fitment of this product on your application.
 - Vehicles that had previous body damage may have more difficulty with correct installation, depending on repairs.
- ⦿ Before installation, check the parts list to be sure all parts are received.
- ⦿ This part is not meant to fit with other aero parts.
- ⦿ Please keep the product out of direct sunlight before mounting, surface temps reaching 104 degrees F and above may cause warping.
- ⦿ GReddy will not handle any warranty claims after it has been altered.

Mounting Notes

⚠ Warning Please follow the manufacturer's instructions and guidelines for basic maintenance.

⚠ Note

- Wear protective goggles and masks.
- After making modifications to factory metalwork, be sure to cover the areas with paint to prevent rust..

⚠ Note After painting the parts, attach the parts to the vehicle slowly as to not crack the paint.

<350Z Front Bumper Installation>

This product is meant to fit Nissan 350Z only. Please check the parts before mounting.

■ Parts List

Front Bumper Cover × 1

■ Mounting Procedure

- 1) Please follow the manufacturer's repair manual for proper front bumper cover removal procedure.
(※Remove the side bracket from the OEM bumper.)
(※Remove the impact foam from the front of the bumper.)
 - 2) Install the side bracket onto the GT bumper by reversing the steps used to remove it.
 - 3) Install the GT bumper using the factory clips and screws to the original locations.
- This completes the installation.**

Note 1 : This job is recommended for 2 people.

Note 2 : Temporarily install the bumper to check fitment before painting.

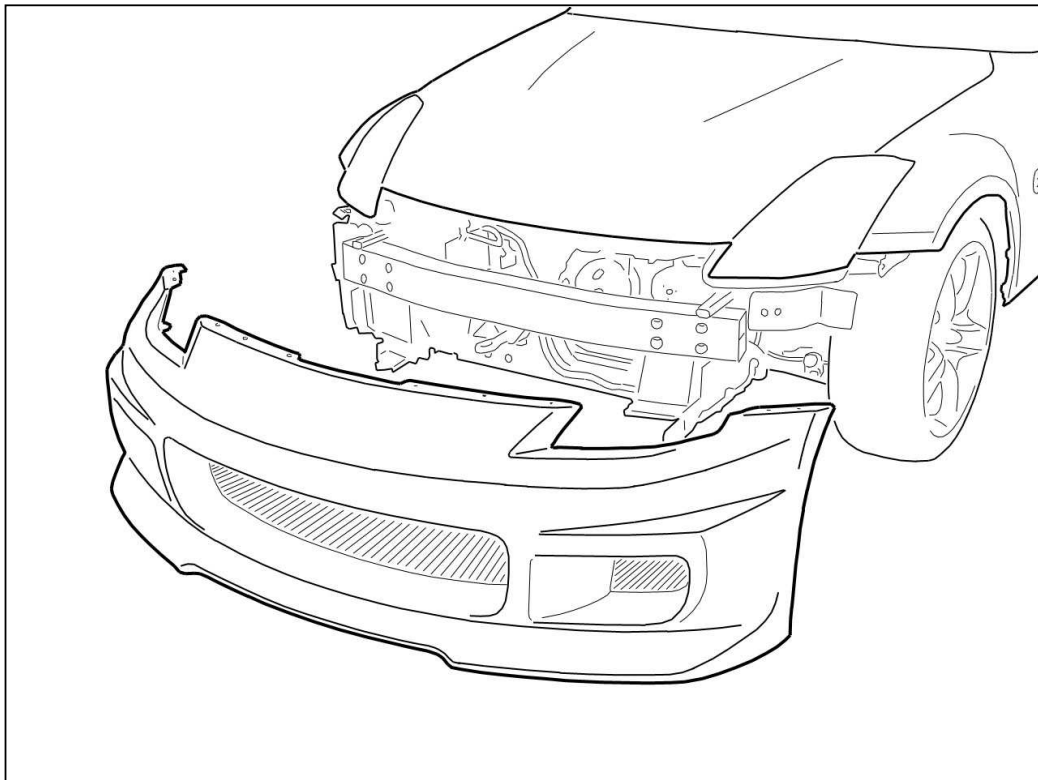

GReddy AERO KIT

350Z GT Wide Fender Kit

Installation Manual

About this Instruction Manual

IMPORTANT

- ⦿ Please read these instructions before installation.
- ⦿ This is for installation on a stock vehicle.
- ⦿ Please keep this manual as long as you own the product.
- ⦿ This document includes the following notes:

 **Warning** Serious injury or life threatening situations can occur if the warning is disregarded.

 **Note** Installation should be done by professionals.

Before Mounting

Important Please be sure to read.

- ⊙ This product is for off-road use only.
- ⊙ Installation and painting should be done by professional paint shops only.
 - Mounting painted products requires special tools and professional experience.
- ⊙ During the mounting process, modifications may need to be made to the vehicle body.
 - During modifications, please exercise proper safety.
- ⊙ Please do all vehicle inspections and maintenance before attempting installation.
 - Please confirm below fitment of this product on your application.
 - Vehicles that had previous body damage may have more difficulty with correct installation, depending on repairs.
- ⊙ Before installation, check the parts list to be sure all parts are received.
- ⊙ This part is not meant to fit with other aero parts.
- ⊙ Please keep the product out of direct sunlight before mounting, surface temps reaching 104 degrees F and above may cause warping.
- ⊙ GReddy will not handle any warranty claims after it has been altered.

Mounting Notes



Warning

Please follow the manufacturer's instructions and guidelines for basic maintenance.



Note

- Wear protective goggles and masks.
- After making modifications to factory metalwork, be sure to cover the areas with paint to prevent rust..



Note

After painting the parts, attach the parts to the vehicle slowly as to not crack the paint.

<350Z GT Wide Fender Kit>

This product is meant to fit Nissan 350Z only. Please check the parts before mounting.

■ Parts List

Left & Right Front Fender	× 1 Each
Left & Right Rear Fender	× 1 Each
Fuel Lid with Key lock	× 1
Key for Fuel Lid	× 2
Double Sided Tape (1.2 × 10 × 2.5m)	× 4
Rivets (4mm)	× 50

■ Mounting Procedure

- 1) Remove the factory fuel lid from the vehicle.
- 2) Temporarily tape the fenders onto the body to get them in the correct positioning.

Mark the mounting points so you are able to drill in the correct positions.

Drill the holes and attach the rivets.

- 3) Cover any raw metal with touch up paint or rust stop.

Installation is complete.

Note 1: This job is recommended for 2 people.

Note 2: Temporarily mount the fenders to check fitment before painting.

Note 3: Be sure to use a surface degreaser and sand the material before applying primer and paint.

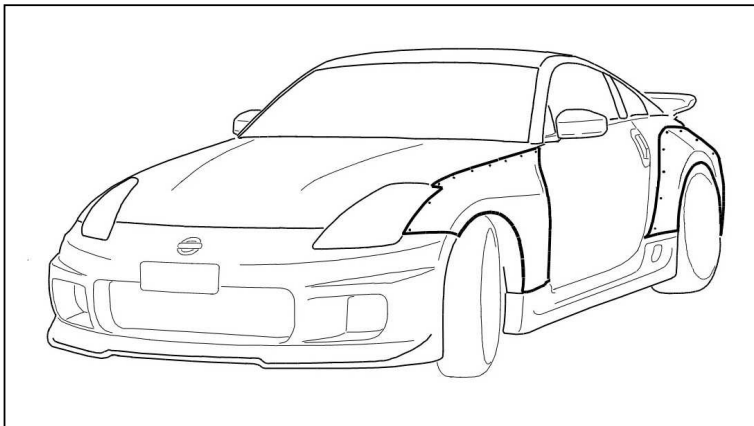
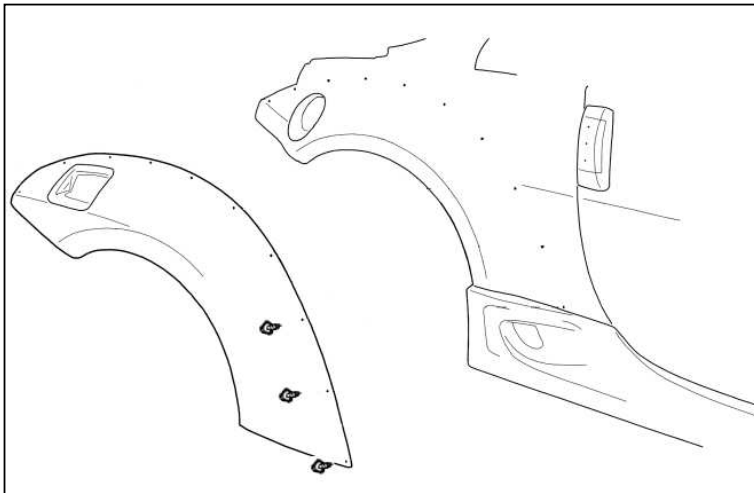

GReddy AERO KIT

350Z GT Side Skirts

Installation Manual

About this Instruction Manual

IMPORTANT

- ⦿ Please read these instructions before installation.
- ⦿ This is for installation on a stock vehicle.
- ⦿ Please keep this manual as long as you own the product.
- ⦿ This document includes the following notes:

 **Warning** Serious injury or life threatening situations can occur if the warning is disregarded.

 **Note** Installation should be done by professionals.

Before Mounting

Important Please be sure to read.

- ⊙ This product is for off-road use only.
- ⊙ Installation and painting should be done by professional paint shops only.
 - Mounting painted products requires special tools and professional experience.
- ⊙ During the mounting process, modifications may need to be made to the vehicle body.
 - During modifications, please exercise proper safety.
- ⊙ Please do all vehicle inspections and maintenance before attempting installation.
 - Please confirm below fitment of this product on your application.
 - Vehicles that had previous body damage may have more difficulty with correct installation, depending on repairs.
- ⊙ Before installation, check the parts list to be sure all parts are received.
- ⊙ This part is not meant to fit with other aero parts.
- ⊙ Please keep the product out of direct sunlight before mounting, surface temps reaching 104 degrees F and above may cause warping.
- ⊙ GReddy will not handle any warranty claims after it has been altered.

Mounting Notes

 **Warning** Please follow the manufacturer's instructions and guidelines for basic maintenance.

 **Note** ● Wear protective goggles and masks.
● After making modifications to factory metalwork, be sure to cover the areas with paint to prevent rust..

 **Note** After painting the parts, attach the parts to the vehicle slowly as to not crack the paint.

<350Z Side Skirt Installation>

This product is meant to fit Nissan 350Z only. Please check the parts before mounting.

■ Parts List

Left & Right Side Skirts	× 1 Each
Grommet	× 10

■ 取付手順

- 1) Remove the factory side skirt according to the factory repair manual specifications.
Remove all factory bolts and clips, including those along the door.
- 2) Attach the GReddy side skirt in place of the factory side skirt using the supplied and factory hardware as shown by the image.
Installation is complete.

Note 1 : This job is recommended for 2 people.

Note 2 : Please check fitment by mounting the product before painting.

Note 3 : Be sure to use a surface degreaser and sand the material before applying primer and paint.

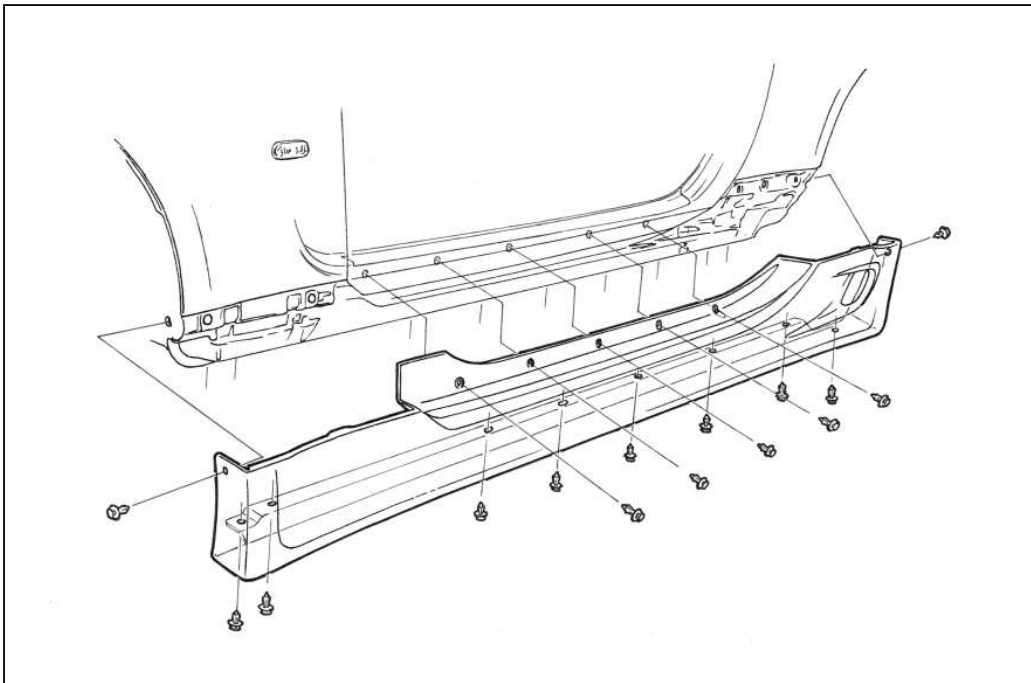

GReddy AERO KIT

350Z GT Aero Rear Bumper

Installation Manual

About this Instruction Manual

IMPORTANT

- ⦿ Please read these instructions before installation.
- ⦿ This is for installation on a stock vehicle.
- ⦿ Please keep this manual as long as you own the product.
- ⦿ This document includes the following notes:

⚠ Warning Serious injury or life threatening situations can occur if the warning is disregarded.

⚠ Note Installation should be done by professionals.

Before Mounting

Important Please be sure to read.

- ⦿ This product is for off-road use only.
- ⦿ Installation and painting should be done by professional paint shops only.
 - Mounting painted products requires special tools and professional experience.
- ⦿ During the mounting process, modifications may need to be made to the vehicle body.
 - During modifications, please exercise proper safety.
- ⦿ Please do all vehicle inspections and maintenance before attempting installation.
 - Please confirm below fitment of this product on your application.
 - Vehicles that had previous body damage may have more difficulty with correct installation, depending on repairs.
- ⦿ Before installation, check the parts list to be sure all parts are received.
- ⦿ This part is not meant to fit with other aero parts.
- ⦿ Please keep the product out of direct sunlight before mounting, surface temps reaching 104 degrees F and above may cause warping.
- ⦿ GReddy will not handle any warranty claims after it has been altered.

Mounting Notes

 **Warning** Please follow the manufacturer's instructions and guidelines for basic maintenance.

 **Note** ● Wear protective goggles and masks.

<350Z Rear Bumper Installation>

This product is meant to fit Nissan 350Z only. Please check the parts before mounting.

■ Parts List

Rear Bumper Cover	×	1
Clip Nuts (M6)	×	2
Bolts (M6 × 16)	×	4
Bumper Bracket	×	2

■ Mounting Procedure

- 1) Please follow the manufacturer's repair manual for proper rear bumper removal procedure.
- 2) Transfer the Rear turn signal, reverse lamp and license plate lamp/rear hatch opener assembly onto the rear bumper.
- 3) Transfer the factory mounting clips onto the rear bumper and by using the factory bolt in screws, mount the rear bumper.
- 4) Reinstall the taillights. This completes the installation.

Note 1 : This job is recommended for 2 people.

Note 2 : Temporarily install the bumper to check fitment before painting.

