

GReddy Supercharger Kit

2000-2002 Toyota Celica GT-S (ZZT231)

MP62 Supercharger kit

GRReddy SUPERCHARGER KIT

Toyota Celica ZTZ231 (2ZZ-GE)

Installation Manual

Please read the manual carefully before installing and using this product.
This product is for off road use only.

MAKE	MODEL	CHASSIS	ENGINE	YEAR
Toyota	Celica GT-S	ZTZ231	2ZZ-GE	2000 - 2002

- For OE air cleaner or GRACER AIRINX SET.
The AIRINX SET is required for vehicles with auto cruise control. The OE air cleaner box will not fit on these vehicles.
- This kit was designed for manual transmission vehicles.

The use of an air filter other than our GRACER AIRINX set with the supercharger kit may cause lean burning conditions. Please refrain from using aftermarket intake systems other than our GRACER AIRINX kit to prevent any possible engine damage.



Important

This kit is designed for the vehicle specified above.
Please do not attempt to install this kit on other application.

Important

1. This installation should only be performed by a trained specialist who is very familiar with the automobile's mechanical, electrical and fuel management system.
2. If installed by an untrained person, it may cause damage to the kit as well as the vehicle.
3. GRReddy Performance Products Inc. is not responsible for any damage to the vehicle's electrical system caused by improper installation.
4. Make sure to follow the instruction and pay attention to the "Important", "Warning!" and "Caution!" notice through out the instruction.
5. Improper installation can be **dangerous!** Please make sure to inspect the installation before operating the vehicle.
6. Call your GRReddy Authorized dealer or GRReddy Performance Products if there are any problems or questions regarding this product.

1. Parts List

1.	Supercharger MP62	(W/ Pulley)							1
2.	Intake Manifold								1
3.	Intake Tube								1
4.	Tensioner Pulley								1
5.	Supercharger Belt	(6PK-2475)							1
6.	Alternator Bracket,	Upper							1
7.	"	Lower							1
8.	"	Floating Nut							1
9.	Oil Dip Stick Guide								1
10.	Spacer,	Tensioner Pulley							1
11.	"	Alternator Bracket	(20 φ × 15mm)						2
12.	"	Intake Tube Bracket	(18 φ × 20mm)						1
13.	Bracket,	Alternator Bracket							1
14.	"	Intake Tube							1
15.	"	Cruise Control							1set
16.	Vacuum Hose	6 φ × 150mm							1
17.	Cable Tie	100mm							5
18.	"	200mm							5
19.	Colgate Tube	7 φ × 1500mm							1
20.	Cruise Control Extension Harness	(700mm) × 4, Connectors & Sleeve (M•F) × 8							1set
21.	Injectors	440 cc (W/ Harness Coupler)							4
22.	e-manage Ultimate	US-ZZT231							1
23.	"	Harness [Connectors & Sleeve (M•F) × 21 / Splice Connector × 7]							1 set
24.	M6 × 15mm	P1. 0	Stainless	B	S/W	—	—	(Cruise Control Bracket)	2
25.	M8 × 15mm	P1. 25	Stainless	B	S/W	—	—	(Alternator Bracket)	2
26.	M8 × 25mm	P1. 25	Stainless	B	S/W	—	—	(Intake Tube, Alternator Bracket)	4
27.	M8 × 30mm	P1. 25	Stainless Stud	B	S/W	—	N	(Charger OUT)	6
28.	M8 × 38mm	P1. 25	Stainless Stud	B	S/W	—	N	(Intake Manifold)	5
29.	M8 × 50mm	P1. 25	Stainless	B	S/W	—	—	(Intake Tube Bracket)	1
30.	M8 × 90mm	P1. 25	Stainless	B	S/W	—	—	(Alternator Bracket, Engine Side)	2
31.	M10 × 25mm	P1. 25	Stainless	B	S/W	—	—	(Intake Tube Bracket, Engine Side)	1
31.	M10 × 70mm	P1. 25	Steel Bolt	B	S/W	F/W	—	(Alternator Bracket)	1
32.	M12 × 70mm	P1. 5	Steel Bolt	B	—	—	—	(Tensioner Pulley)	1

Part List Diagrams/Pictures

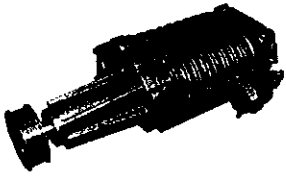

1

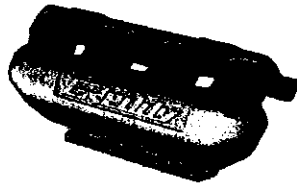

2



3



4

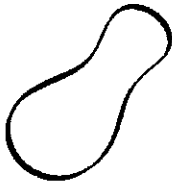

5



6

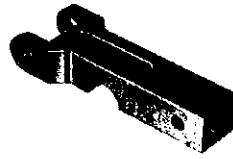

7



8



9



10



11



12

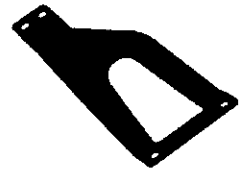

13



14

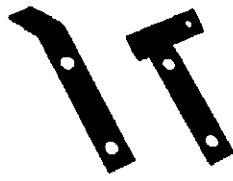

15

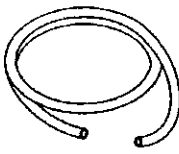

16

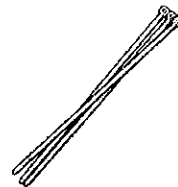

17, 18



19



20



21

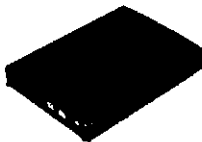

22



23

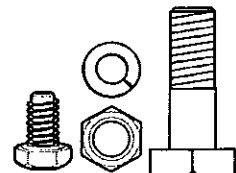

24~32

2. OEM Parts Removal

Please refer to factory repair manual for OE component removal guidance.

2-1 Safely remove pressure from fuel lines.

- (1) Remove the circuit-opening relay located in the fuse box in the left side of the engine bay.
[C/O : circuit opening relay]
- (2) Crank the motor to remove fuel pressure. Turn ignition key off.
- (3) Remove the battery - and + terminal.
- (4) Install the circuit-opening relay to its original location.
- (5) Open fuel tank filler cap to remove pressure in fuel tank.

2-2 Remove the upper front fender apron seal (53735G), upper radiator support seal (53292A), and cylinder head cover No. 2 (11212).

2-3 Remove the battery and battery tray.

2-4 Remove the engine under cover and drain the coolant from the radiator drain cock.

2-5 Remove the Engine bay ECM outlet duct [82776], air cleaner case [17700], and air cleaner hose No. 1 [17881A].

2-7 Remove the accelerator control cable from the throttle lever. Remove the water bypass hose, ventilation hose No. 2 [12262], and harness connectors from the throttle body. Remove throttle body Assy.

- ※ Mark or label water bypass hose to prevent confusion during install.

Cars with Auto Cruise Control

- (1) Remove the accelerator control cable from the throttle lever. Remove harness connector and bolts. Remove the auto cruise control unit Assy.
- (2) Remove the bracket from the control unit. Remove the four rubber grommets from bracket.

2-8 Remove the alternator bracket, oil dip stick guide, and oil dip stick.

- ※ Plug the dipstick guide hole on the engine block to prevent dirt from entering motor.

2-9 Remove the radiator reserve tank bolts and place the reserve tank on the hood latch. Disconnect the ventilation hose No. 1 (12261) and remove the intake air surge tank.

2-10 Move the V belt tensioner to the front of the vehicle and remove the V belt.

2-11 Disconnect the harness connectors for the cam position sensor, A/C compressor, knock sensor, crank position sensor, and injectors to allow the harness to move freely.

2-12 Disconnect the B+ connector and harness connector on the alternator and remove alternator.

2-13 Remove ventilation tube No. 1 [12221].

3. Kit Install

3-1 OE ventilation Tube No. 1 Modification

Remove the bracket from the ventilation tube in 2-13. Install back to same location.

- ※ After removing bracket, make sure to de-burr and paint surface of modified area.



Please use safety glasses and a mask to prevent injury.

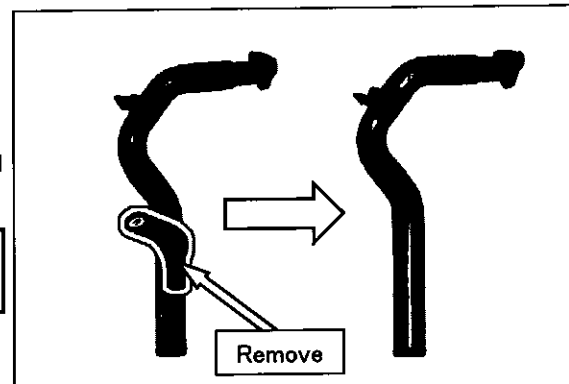

3-2 Kit Lower Alternator Bracket Install

- (1) Remove the two lower bolts of the A/C compressor brackets. Place the provided spacers between the kit alternator bracket and OE compressor bracket.

- ※ Replace the two bolts with the provided bolts. Do not torque these bolts at this time.

〈Parts No.11, 13, 30〉

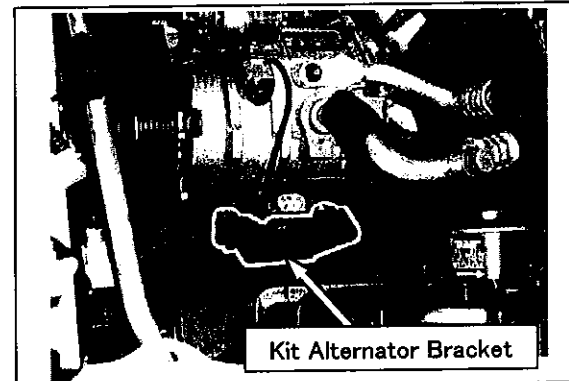

- (2) Place the floating nut in the lower alternator bracket.

〈Parts No.7, 8〉

- (3) Install the lower alternator bracket to the engine block using the provided bolt and attach the alternator bracket (1) to the lower alternator bracket.

- ※ Torque bolts in this order:
A/C compressor bracket, lower alternator bracket (engine block side), alternator bracket.

〈Parts No.25, 31〉

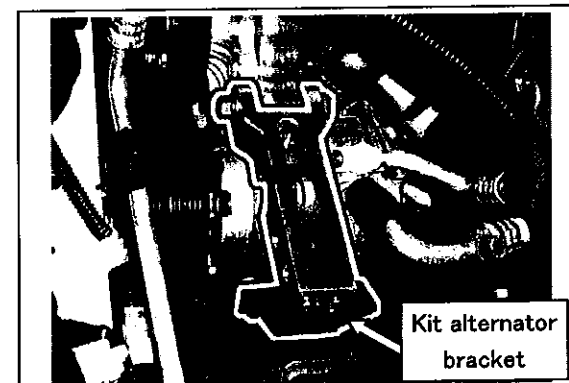
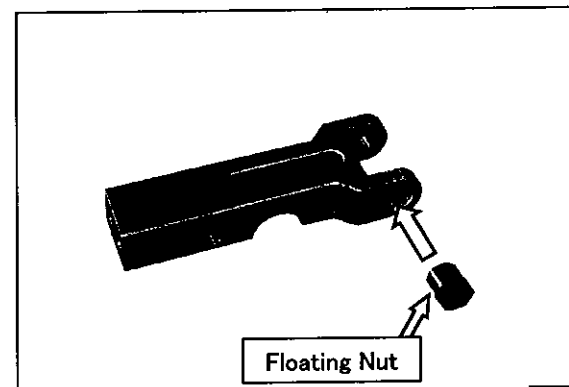

3-3 Kit Supercharger assembly

- (1) Screw in the provided stud bolts onto the supercharger outlet flange and apply silicone sealant to the flange surface. Attach Kit intake manifold to the supercharger.
- ※ Try to prevent sealant from protruding to the inside of the manifold.

〈Parts No.1, 2, 27〉

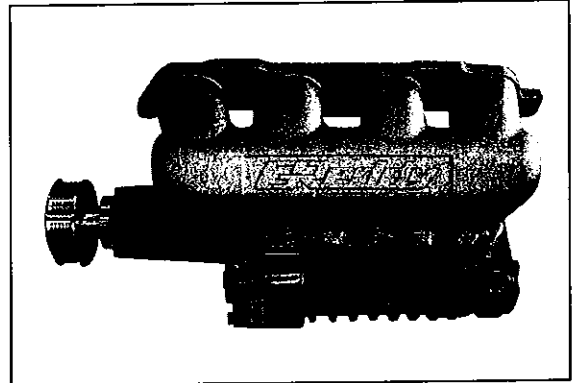

- (2) Connect the actuator port to the intake manifold port using the 6mm hose provided. Secure hose ends with cable ties.
- ※ When using a boost gauge, use this pressure source to monitor intake manifold pressure.

〈Part No.16, 17〉

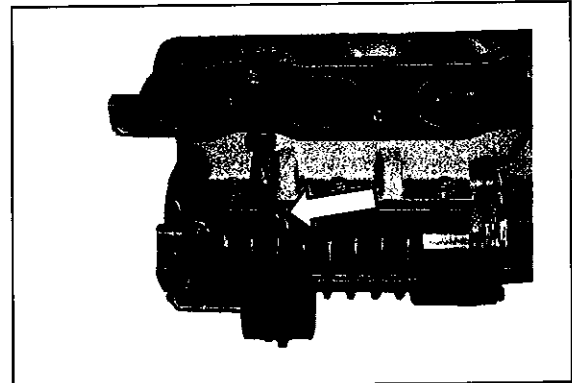

3-4 S/C Assy Installation

- (1) Remove the OEM stud bolts on the intake side of the cylinder head and screw in five of the studs provided.

〈Part No.28〉

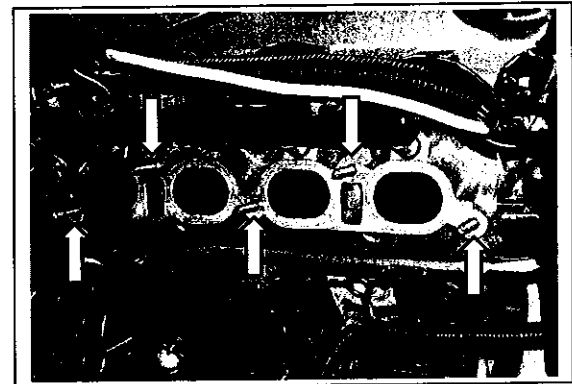

- (2) Place the OEM intake manifold gasket between the intake manifold and head and install manifold
- ※ When installing the intake manifold, place the radiator reserve tank on the hood latch.

〈Part No.28〉

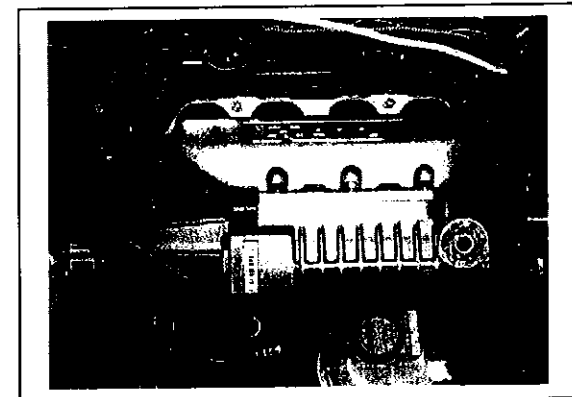

3-5 Kit Oil Dip Stick Installation

- (1) Remove the O-ring from the OE dipstick guide and place it on the Kit dipstick guide.
 - ※ If the O-ring is damaged, please replace with OEM part.

〈Part No.9〉

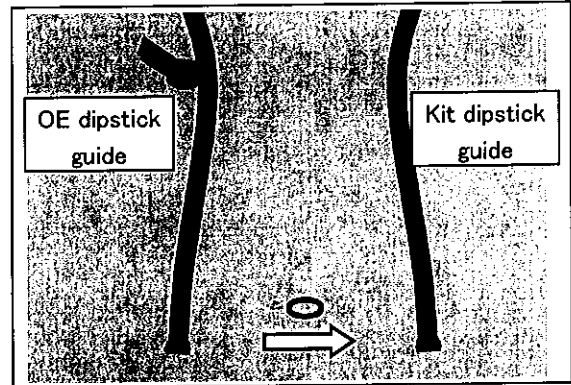

- (2) Place the Kit dipstick guide in the factory location on the engine block and attach the bracket to the supercharger Assy and tighten bolt.

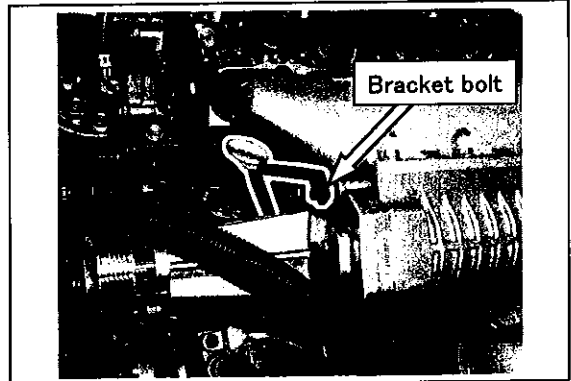

3-6 Alternator Installation

- (1) Attach the alternator to the lower alternator bracket installed in step 3-2.
 - ※ Use OEM bolt
- (2) Attach the upper alternator bracket to the alternator and torque the lower alternator bolt.
 - ※ Use OE bolt on the alternator side of the bracket and provided bolt for the engine side of bracket.

Torque spec: M8 bolt 29N·m (290kgf·cm)

M10 bolt 58N·m (580kgf·cm)

〈Parts No.6, 26〉

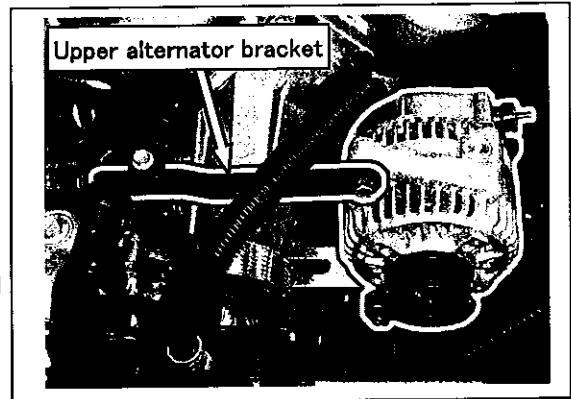

3-7 Kit Tensioner Pulley Installation

- Attach the Kit tensioner pulley to the lower alternator bracket with the spacer between the pulley and bracket. Use the provided bolt to attach pulley to bracket.
- ※ Place the pulley so the rim faces the bracket.
 - ※ Use thread lock on the pulley bolt.

〈Parts No.4, 10, 32〉

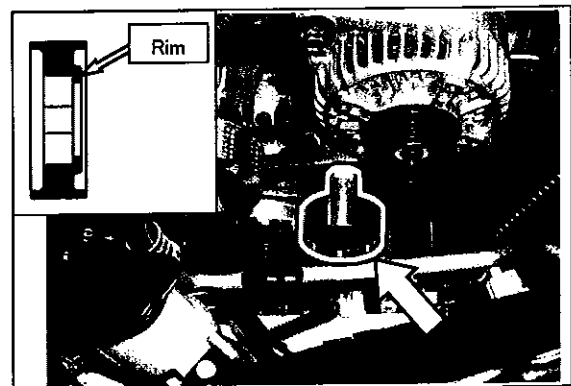

3-8 Kit V Ribbed Belt Installation.

Adjust the tensioner pulley toward the front of the vehicle to adjust belt tension.

(Part No.5)

- VP : Vane Pump Pulley
- CK : Crank Pulley
- CC : Cooler Compressor
- WP : Water Pump Pulley
- AL : Alternator Pulley
- TP : OE Tensioner Pulley
- kit TP : KIT Tensioner Pulley
- SC : Supercharger Pulley

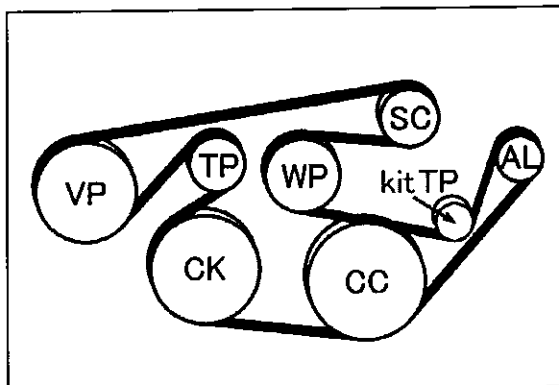

3-9 Kit Injector Installation

- (1) Remove the fuel delivery pipe and fuel injectors

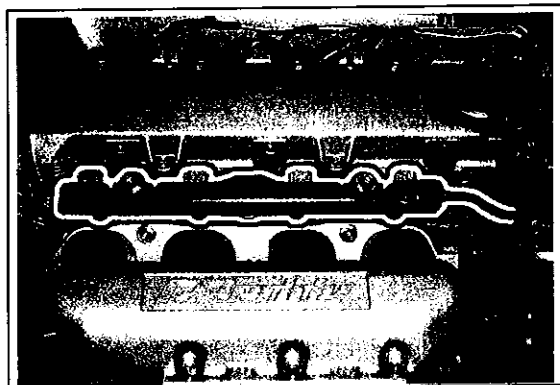

- (2) Replace OE injectors with the provided injectors and install fuel delivery pipe back to original location.



Please check for fuels leaks after kit is installed to prevent injury or damage from fire.

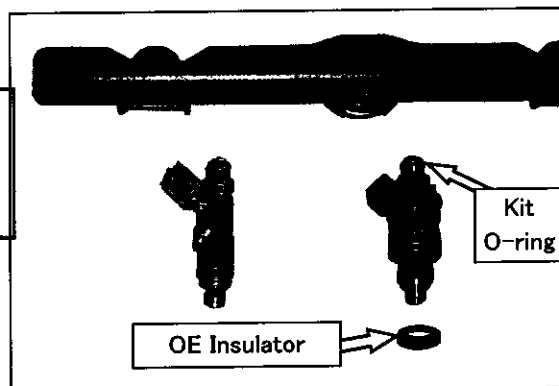

- ※ Use the Kit O-ring to seal the top of the injector. Lubricate O-ring with silicone grease.
- ※ Re-use OE bolts, spacer, and injectors insulators. If the OE Insulator is damaged, please replace.

- ※ Install the injector connectors to face toward the front of the vehicle.

(Part No.21)

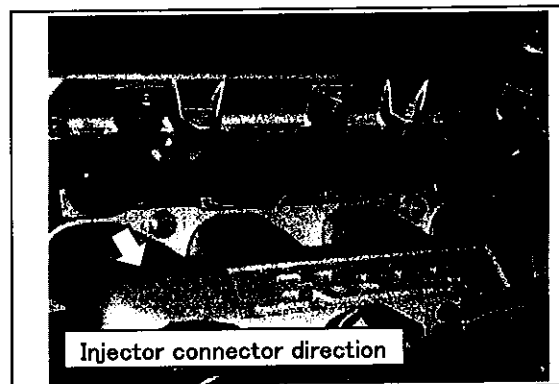

(3) Cut off the OE injector harness connectors and replace with Kit injector harness connectors.

※ Mark or label harness wires to ensure that they are connected to the proper pin on the injector.

※ Do not connect the injector connector at this time.

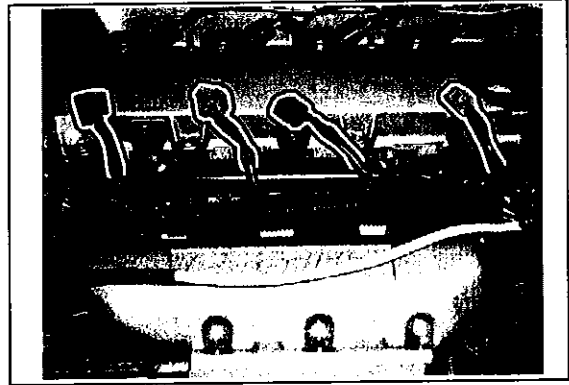

Solder procedure

① Remove sleeve

② Wrap wires together

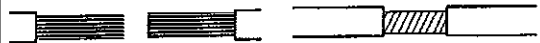

③ Solder wires

④ Wrap with electrical tape

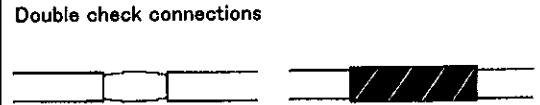

Double check connections

3-10 OE Engine Wire Harness

(1) Split the OE Wire harness in this way: A - alternator B+ wire, B - alternator connector, C - A/C compressor, D - knock sensor, E - crank position sensor. Wrap the wires with the provided colgate tubing.

※ Combine the knock sensor and crank position sensor wire harness into the same colgate tube.

※ Cut the colgate tube to the proper lengths and tape then ends of the tubing with electrical tape.

〈Part No.19〉

(2) Connect the sensor harness connectors and alternator connectors and use cable ties to secure wires. Connect engine harness to injector connectors.

※ Route the alternator B+ wire in front of the supercharger and connect to alternator.

〈Parts No.17, 18〉

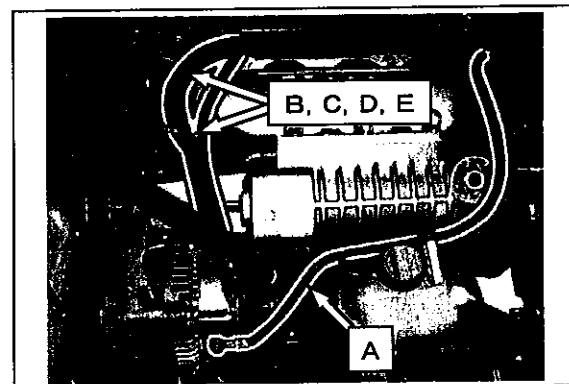
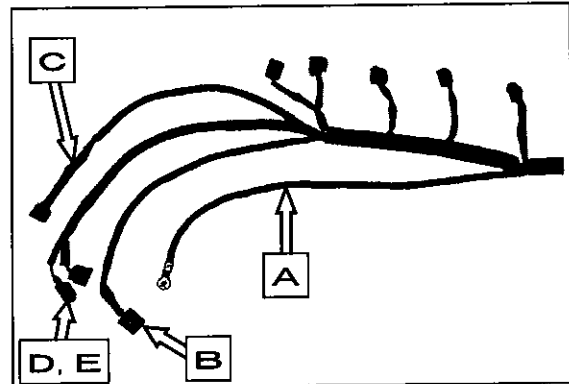

3-11 Kit Intake Tube Installation

- (1) Remove the studs on the OE intake air surge tank and screw them into the Kit intake tube.

(Part No.3)

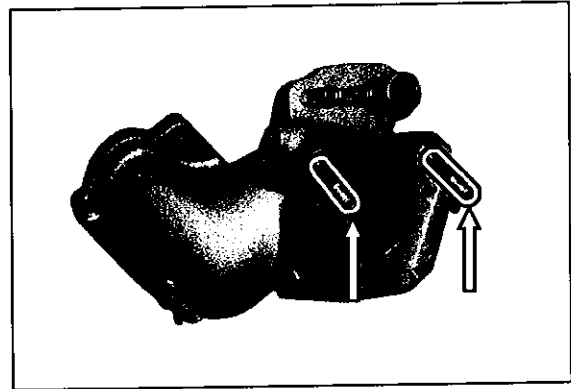

- (2) Attach the Kit intake tube to the supercharger inlet.

At the same time, place the spacer between the Kit intake tube bracket and "Thread A" on the picture and use the M8 x 50mm bolt to secure the bracket. Secure the other end of the bracket to the engine block.

- ※ Use silicone sealant between the supercharger inlet and intake tube flange. Prevent sealant from protruding to the inside of the flange.

- ※ Torque bracket bolts starting from the engine.

(Parts No.12, 14, 26, 29, 31)

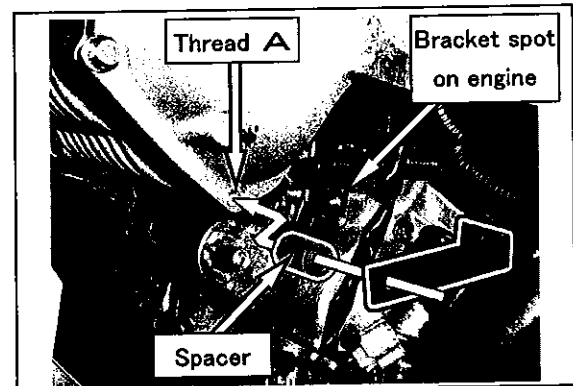
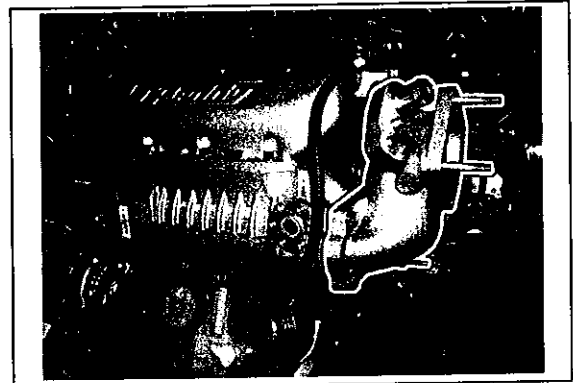

3-12 OE Throttle Body Installation

- (1) Place the OE gasket on the intake tube and install the throttle body, water bypass hose, and electrical connectors.

- ※ Re-use OE bolts and nuts. Please confirm that the throttle body gasket is placed properly also.

- (2) Install the accelerator control cable.

For vehicles without Auto Cruise Control

Install the accelerator control cable bracket to the intake tube using the OE bolts and install the throttle cable to the throttle lever.

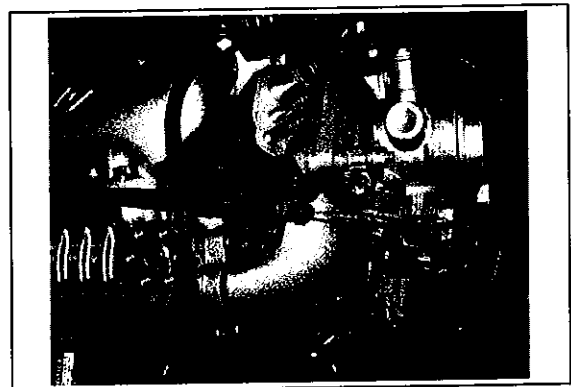

For Vehicles With Auto Cruise Control

- ① Place the rubber grommets removed in step 2-7 between the cruise control unit and the provided auto cruise control brackets. Use OE screws to secure bracket to unit.

〈Part No.15〉

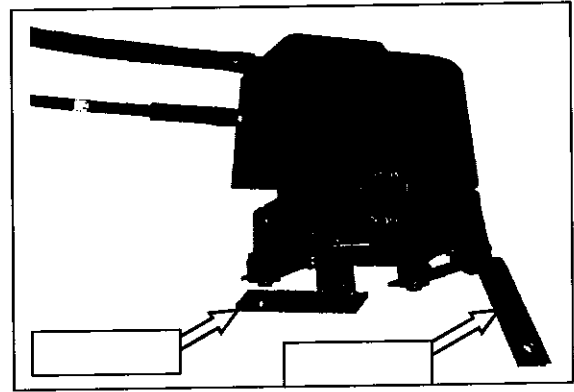

- ② Use the provided bolts to secure the auto cruise control unit Assy to the upper radiator support.

Bolt Location

- A : Hood latch bracket
B : Air cleaner box

〈Part No.24〉

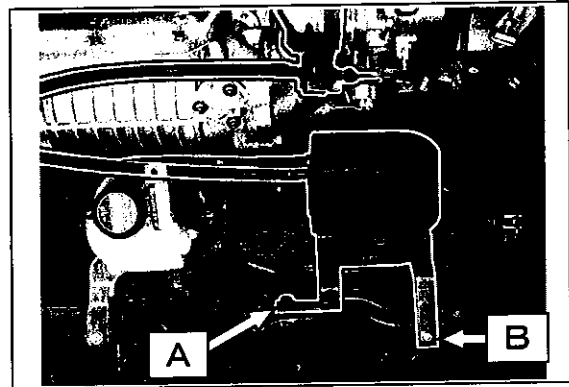

- ③ Cut the auto cruise control harness and use the provided wire to extend the wire.

After soldering wire and wrapping with tape, wrap with colgate tube and connect harness to unit.

- ※ Double check solder for good connection.
- ※ Make sure you have clearance between the harness and V ribbed belt.

〈Parts No.17, 18, 19, 20〉

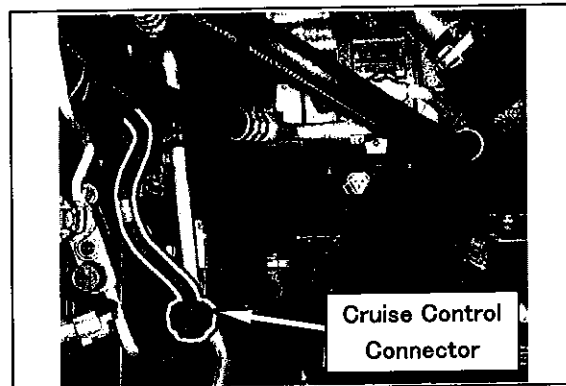

- (3) Connect hoses back to the intake tube and throttle body.

- ※ Re-use OE hose bands.

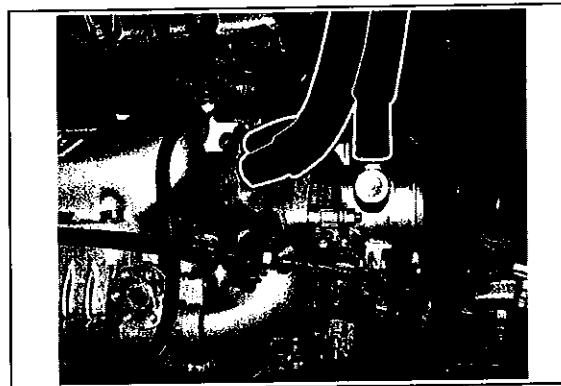

3-13 Kit e-manage Ultimate installation

- (1) Remove the ECM box cover and disconnect and remove connector A, B, and ground from the box. Remove the electrical tape to all the harness grommet to move freely. The ECM is on the right side of the engine bay.

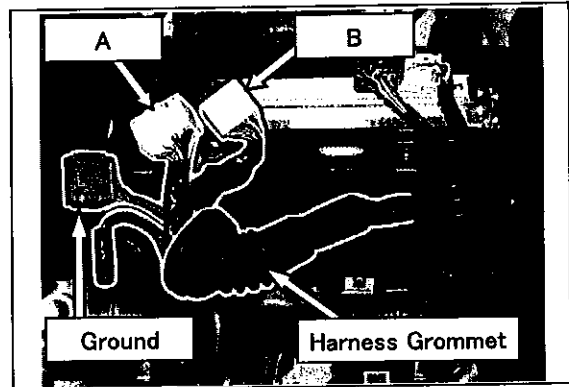

- (2) Locate the A/C line going through the right side of the firewall. Cut the grommet in the center to allow the wire harness to pass through the firewall.



- (3) Route the wire harness through the firewall.

(Part No.23)

- (4) Route the e-manage harness through the ECM harness grommet from the smaller end of the grommet.



- (5) Refer to the wire diagram to connect e-manage wires to the ECM wire harness.

After connections are completed, place all of the wire connectors back in the ECM box and place the harness grommet back to its original location.

- ※ Place the connectors A and B in the ECM box before connectors C and D.

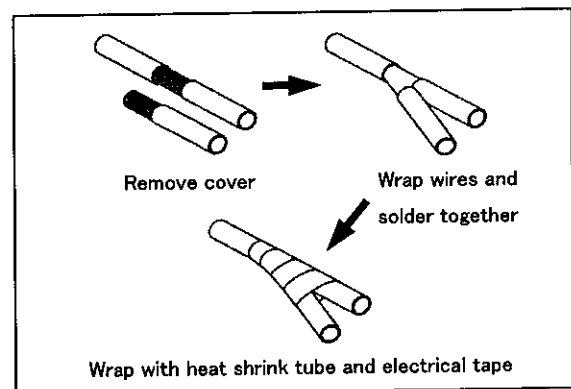

The kit does include connectors for electrical wiring, but it is highly recommended to solder all wire connections to ensure proper function. Also please confirm that all wires are wrapped with electrical tape.

e-manage Ultimate Connector Harness Pin Location

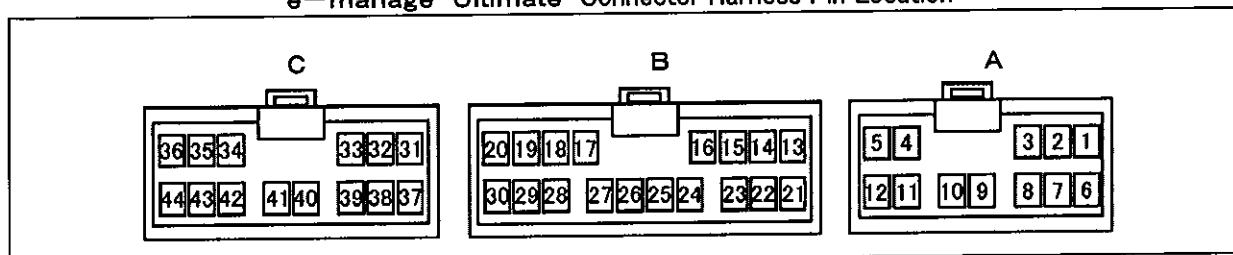

※ Viewing from wire harness side.

Ultimate Pin No.	Signal (Color)	OE ECM Pin No.	Signal
3	Ignition Input CH4 (PL/W)	A_11	Ignition Pulse IGT2 To ECM
4	Ignition Input CH2 (O/W)	A_12	Ignition Pulse IGT3 To ECM
5	Ignition Input CH1 (BL/W)	A_10	Ignition Pulse IGT1 To ECM
8	Ignition Output CH4 (PL/B)	A_11	Ignition Pulse IGT2 To Harness
9	Ignition Output CH3 (Y/B)	A_13	Ignition Pulse IGT4 To Harness
10	Ignition Input CH3 (Y/W)	A_13	Ignition Pulse IGT4 To ECM
11	Ignition Output CH2 (O/B)	A_12	Ignition Pulse IGT3 To Harness
12	Ignition Output CH1 (BL/B)	A_10	Ignition Pulse IGT1 To Harness
14	VTEC Output (Y)	—	—
15	Airflow (Voltage) Input (W)	B_11	VG Air Flow Meter To Harness
16	Throttle Input (GY)	B_23	VTA Throttle Signal
17	Injector Input CH1 (BL/R)	A_1	#10 Injector Pulse To ECM
18	Injector Input CH2 (O/R)	A_2	#20 Injector Pulse To ECM
19	Injector Input CH3 (Y/R)	A_3	#30 Injector Pulse To ECM
20	Injector Input CH4 (PL/R)	A_4	#40 Injector Pulse To ECM
22	Airflow (Voltage) Output (G)	B_11	VG Air Flow Meter To ECM
23	RPM Signal (BR)	C_27	TACH RPM Signal
24	Ground (B)	B_17	E1 Ground
25	IG Power (R)	D_16	+B Battery Power
30	Injector Ground (B/R)	A_21	E01 Injector Ground
33	Crank Angle Signal (GY/W)	—	—
34	Injector Output CH1 (BL/GY)	A_1	#10 Injector Pulse To Harness
35	Injector Output CH2 (O/GY)	A_2	#20 Injector Pulse To Harness
36	Injector Output CH3 (Y/GY)	A_3	#30 Injector Pulse To Harness
39	Camshaft Angle Signal (GY/B)	—	—
40	Vehicle Speed Output (BR/Y)	—	—
41	Vehicle Speed Input (LB/Y)	—	—
42	Injector Output CH4 (PL/GY)	A_4	#40 Injector Pulse To Harness

These wires are outlined in the e-manage diagram. These wires will not be used in this kit. Use electrical tape to cover the ends of the wires to prevent short circuit.

- No.14 VTEC Output(Y)
- No.33 Crank Angle Signal(GY/W)
- No.39 Camshaft Angle Signal(GY/B)
- No.40 Vehicle Speed Output(BR/Y)
- No.41 Vehicle Speed Input (LB/Y)

OE ECM Wire Pin Diagram

※Viewing from wire harness side

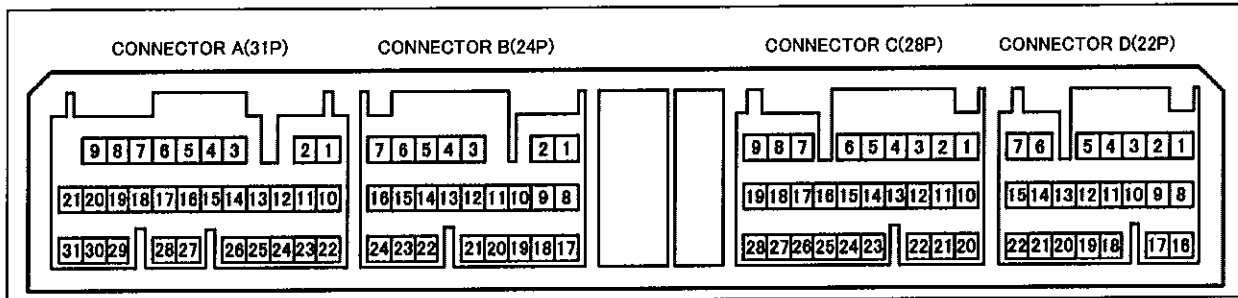

e-manage Ultimate Wire Diagram

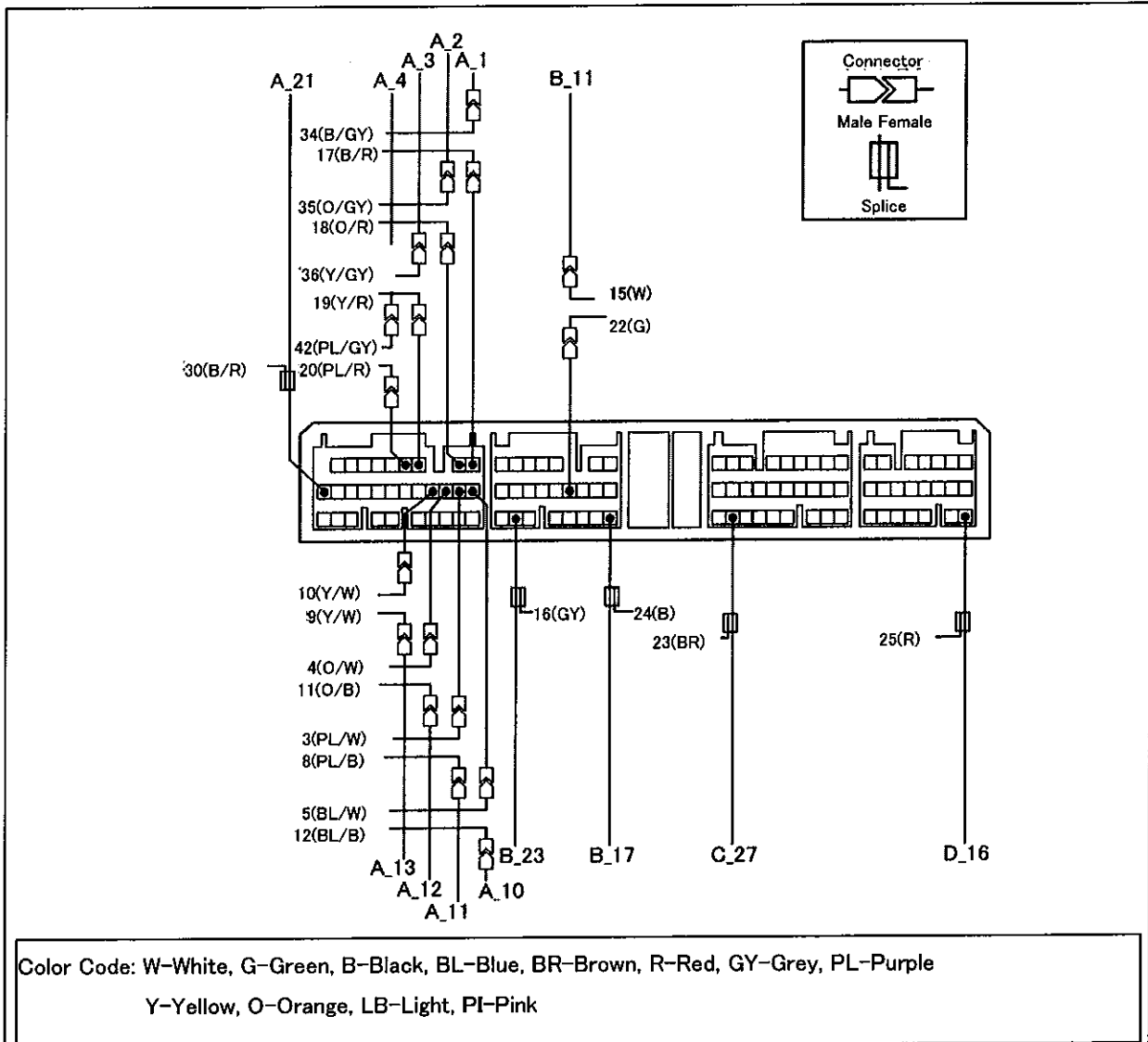



- (6) Route the e-manage ultimate wire harness safely through the engine bay and use cable ties to secure the harness and prevent it from moving. Place the A/C line grommet in its original location.
- ※ Use cable ties to secure the harness to the accelerator control cable secure areas. (Part No.18)
- (7) Adjust the dipswitches on the e-manage Ultimate unit. Secure the unit and plug in the harness connectors.
- ※ Refer to the diagram below for dipswitch instructions.

	<p>It is important that you adjust these switches properly. Engine damage may be caused if not set properly</p>
---	---

- ※ Secure the e-manage unit in an area free from moisture, dust, sunlight, and direct heat from the heater vents.
- ※ Please try to avoid placing the e-manage unit under the carpet or floor mats.

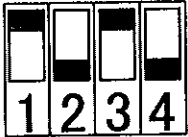
○ Front Panel Dip Switch Settings

Application	Switch Setting
•Use with OE Air Cleaner Box	 <p>※1,3-ON</p>
•Use with AIRINX Filter Kit •Factory setting	 <p>※1,2,3,4-ON</p>

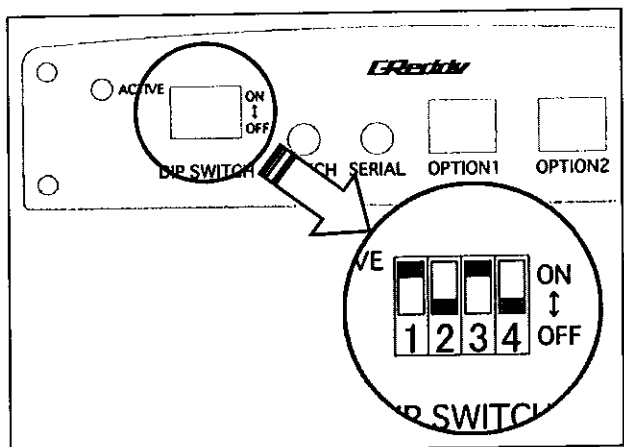

3-14 OE Air Cleaner Installation

Install the air cleaner case, air cleaner hose No.1, engine bay ECM outlet duct, and upper radiator support seal.

- ※ If installing AIRINX Air Filter Set, refer to AIRINX instruction manual.

3-15 OE Cylinder Head Cover Modification

Cut the highlighted portion of the cylinder head cover No.2 in the picture on the right.

Re-use the OE bolts.

	<p>Please use safety glasses and a mask to prevent injury.</p>
---	--

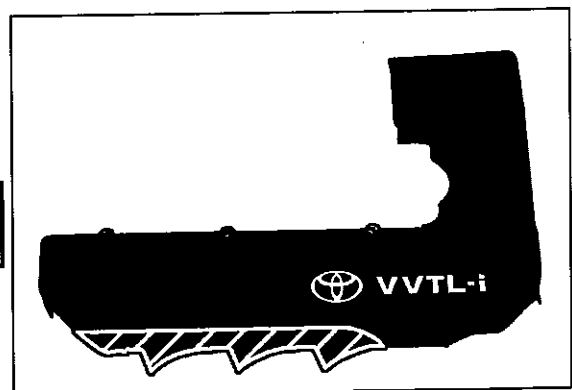

3-16 Starting the Engine

- (1) Install the radiator reserve tank to its original location and fill with coolant.



Bleed the air from the cooling system after starting engine.

- (2) Install the battery tray and battery. Connect the B+ terminal of the battery.
- (3) Inspect all harness connectors and wire connections and connect the B - terminal of the battery.
- (4) Start the engine and inspect fuel lines and injectors for any fuel leaks.
 - ※ Check the e-manage unit to see if the active light is green. If it is not, please check the e-manage wire connections to the OE ECM.
 - ※ Check to see if the e-manage unit has error codes (active light blinks red).
- (5) At idling, inspect for water or vacuum leaks.
- (6) Install the RH engine under cover.
- (7) Install the upper front fender apron seal and cylinder head cover No.2.

This completes the **GReddy** Supercharger Kit installation

IMPORTANT

- It is very important that you monitor the boost pressure, and make sure not to over boost. Over boosting can cause engine damage.
- GReddy Performance Products, Inc. is not responsible for any engine damage caused by over boosting (increased boost), modification to the kit, and/or misuse of the product. NO WARRANTY is offered.
- Due to lack of control over proper installation and use of this product, NO WARRANTY is offered for this kit.

Fig. 5304/ Front Fender Apron & Dash Panel
(9908-)

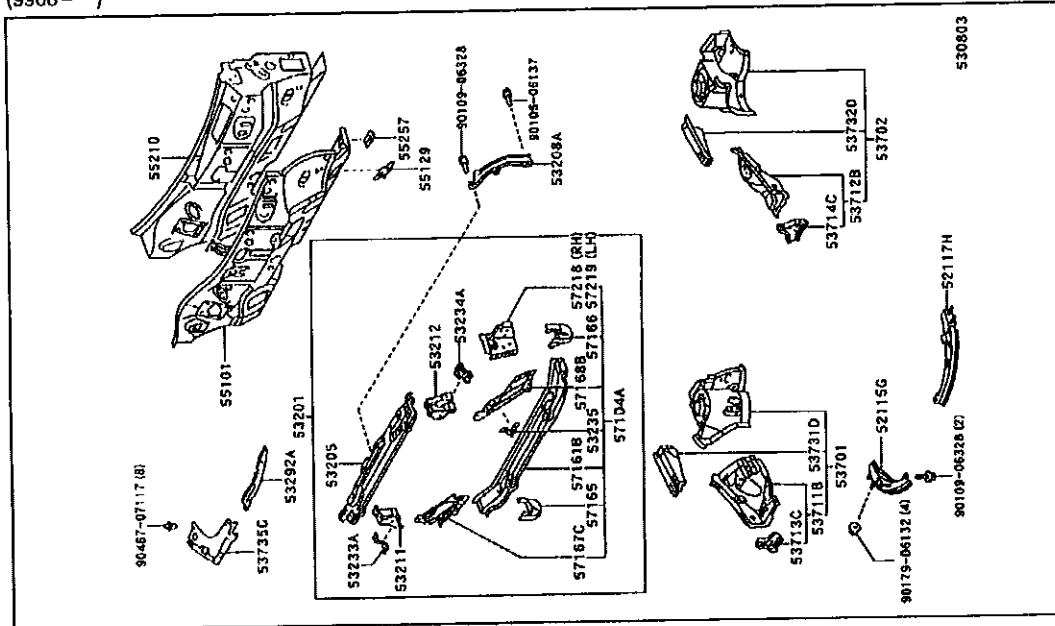
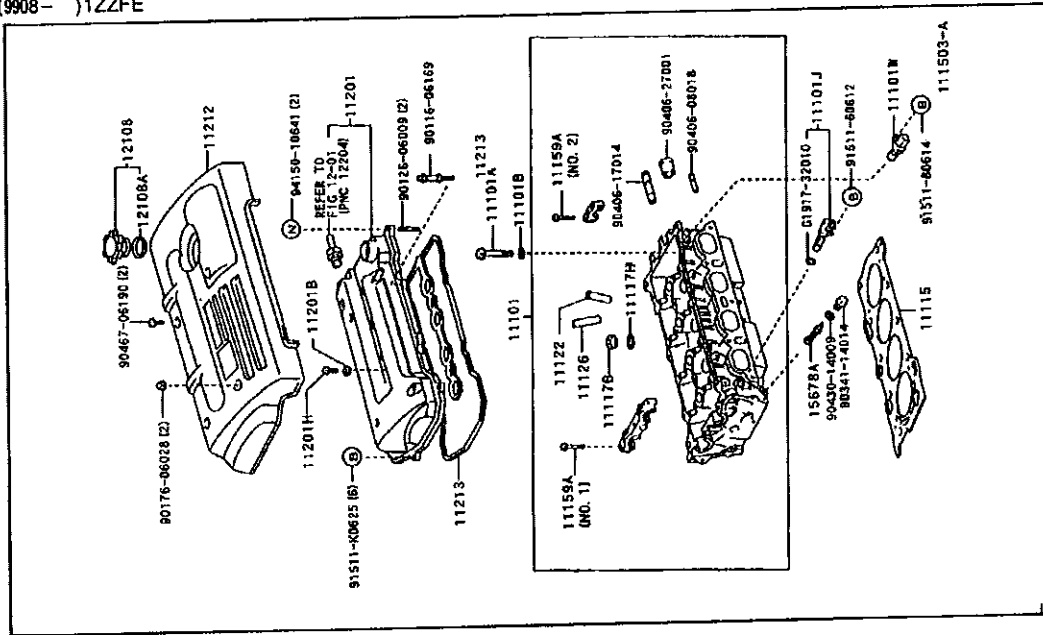

Fig. 1104 Cylinder Head

(9908 -)1ZZFE



PI

(9908 -)2ZZGE

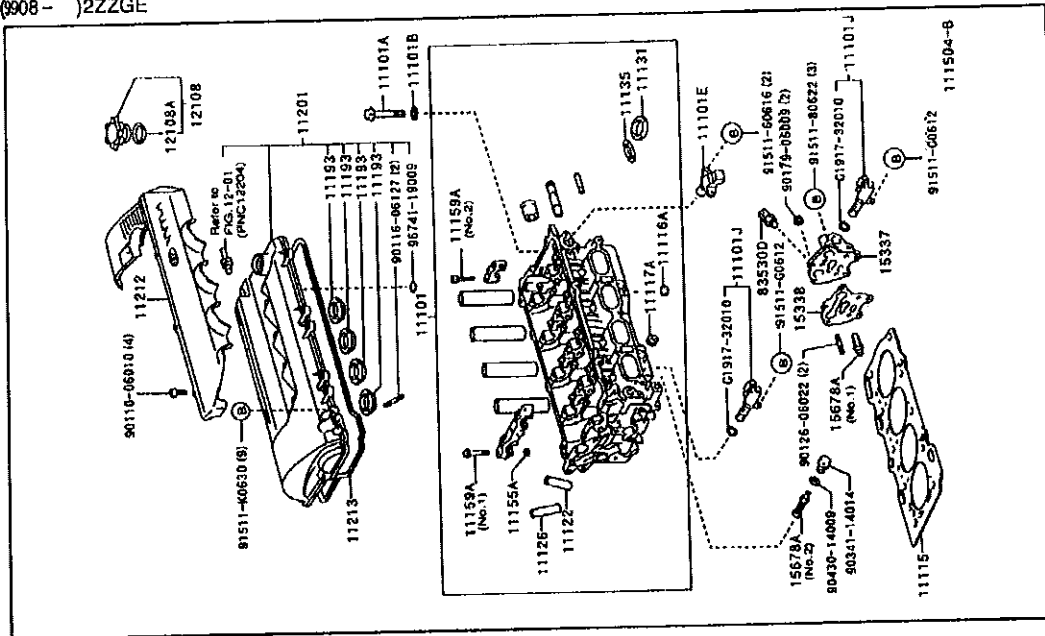
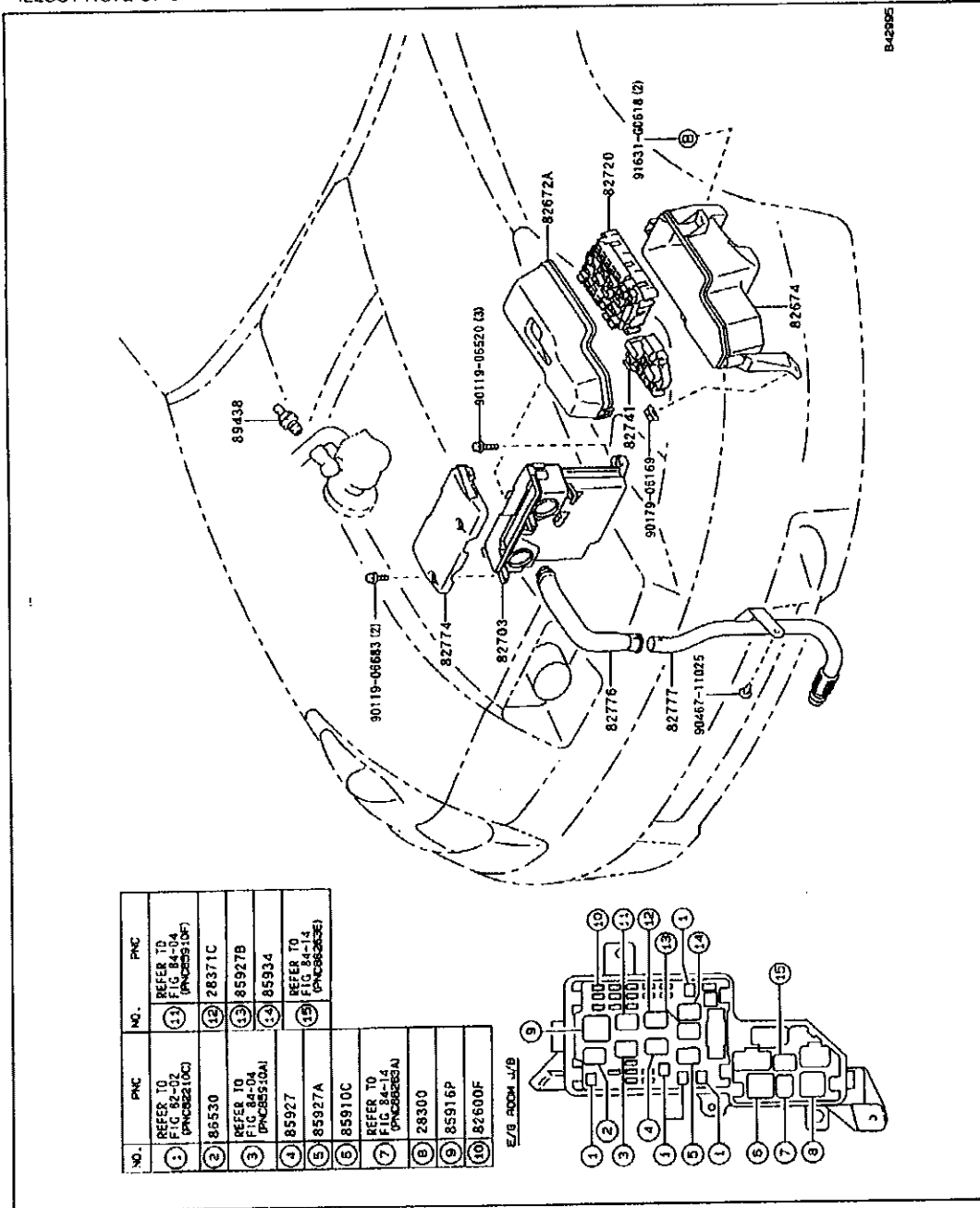

Fig. 8401/ Switch and Relay

(9908--)

179' 7N-A

ILLUST NO. 2 OF 6



B-2905

NO.	PNC	NO.	PNC
1	REFER TO FIG. 84-10 (PNC-82100)	11	REFER TO FIG. 84-14 (PNC-85910F)
2	85530	12	28371C
3	REFER TO PNC-85510A	13	85927B
4	85927	14	85934
5	85927A	15	REFER TO FIG. 84-14 (PNC-86263E)
6	85910C		
7	REFER TO PNC-86263A		
8	28300		
9	85916P		
10	82600F		

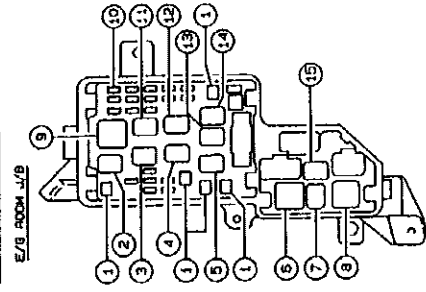

Fig. 1703/ Air Cleaner
(8908-)

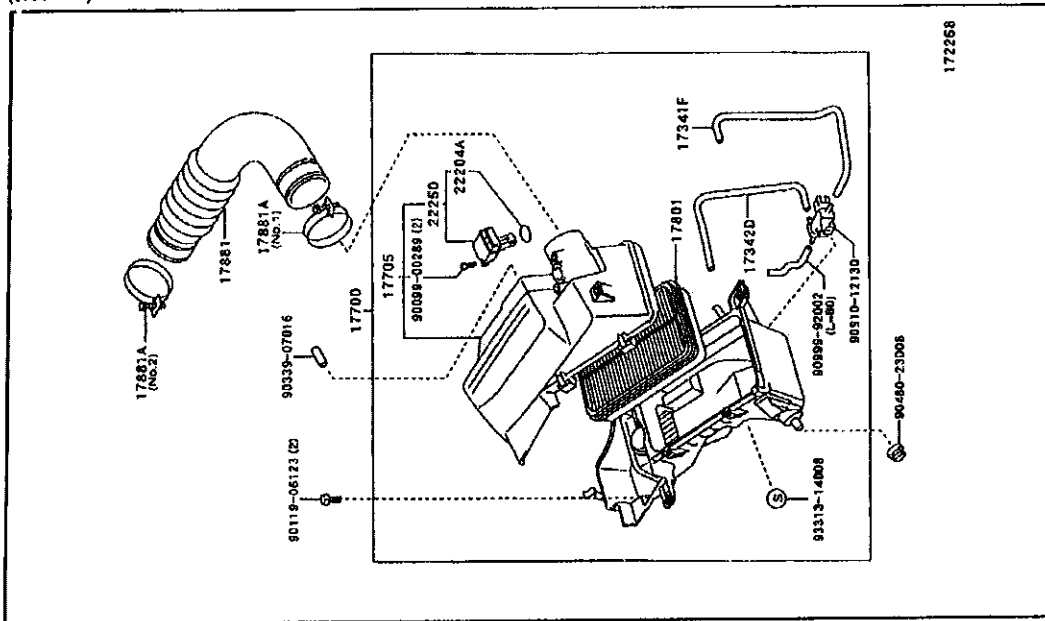
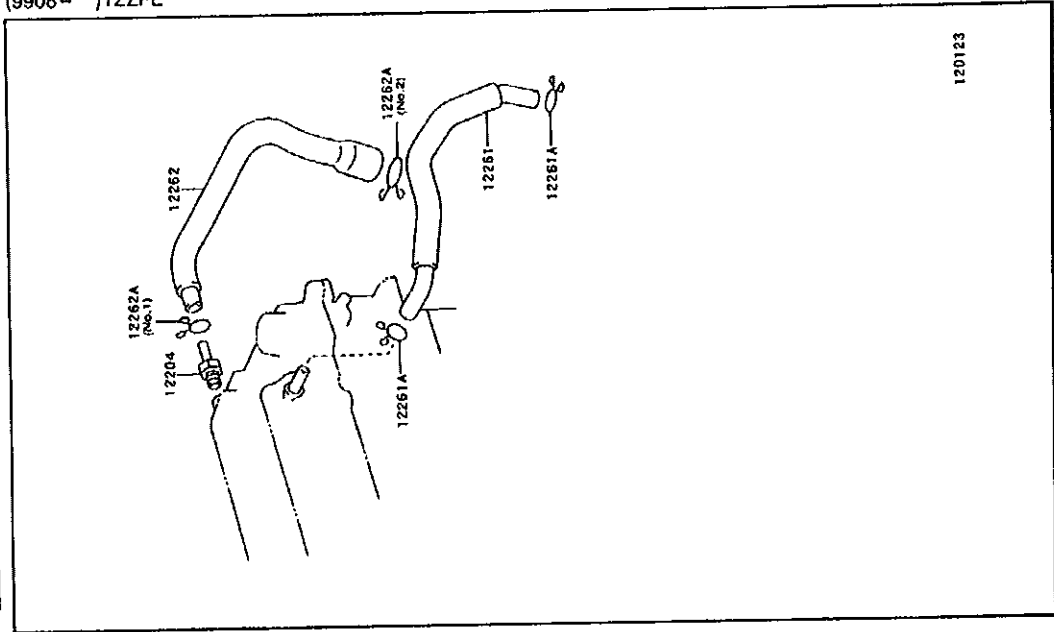

Fig. 1201/ Ventilation Hose

(9908-)1ZZFE

PI



12013

(9908-)2ZZGE

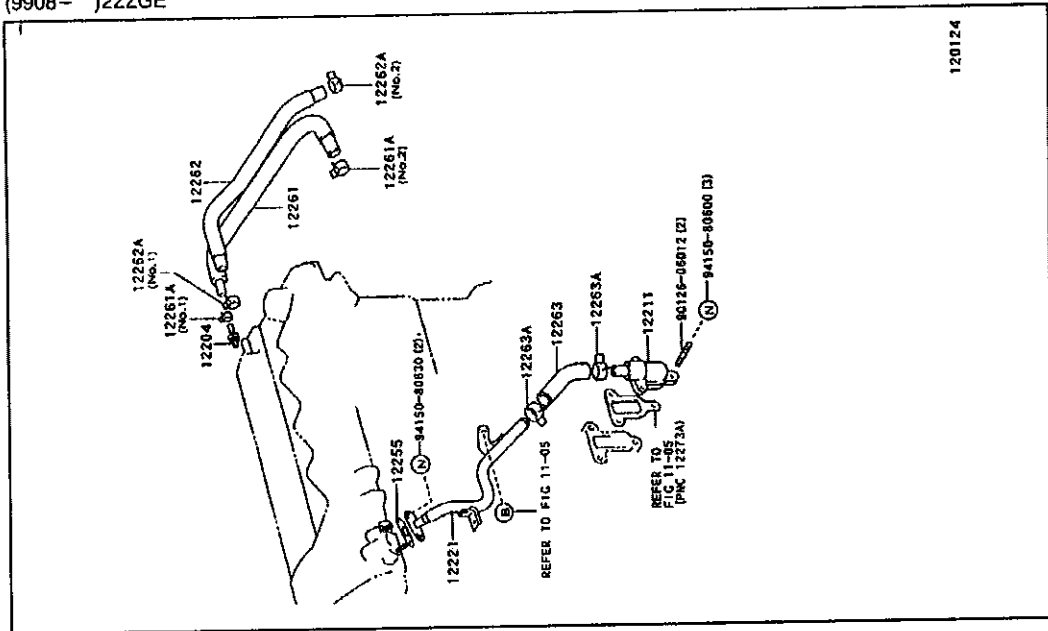

12014

Fig. 1105/ Cylinder Block
(9908-)1ZZFE

PI

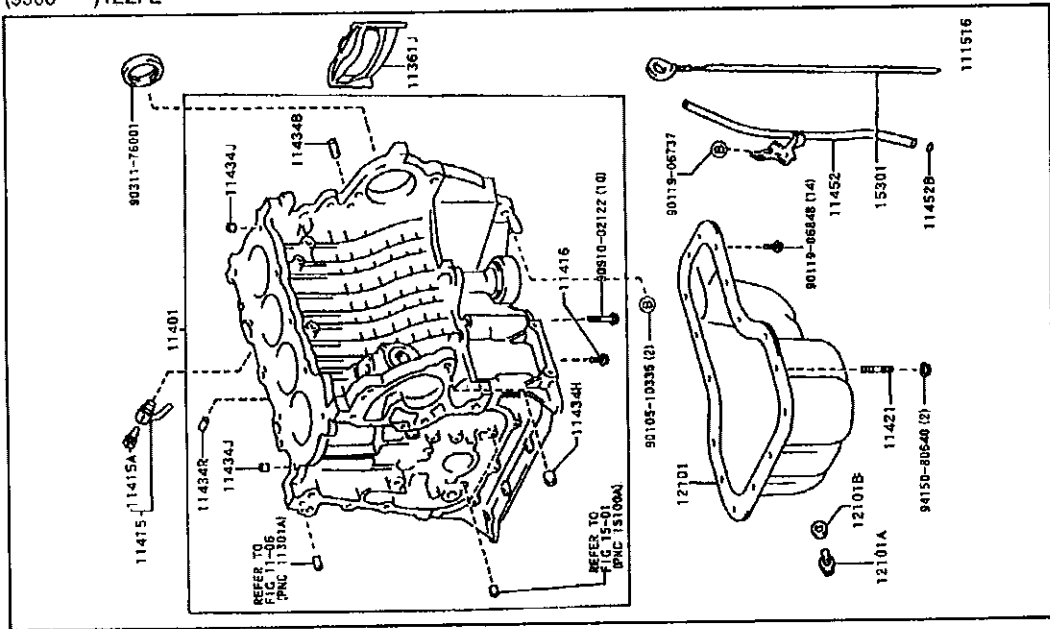

(9908-)2ZZGE

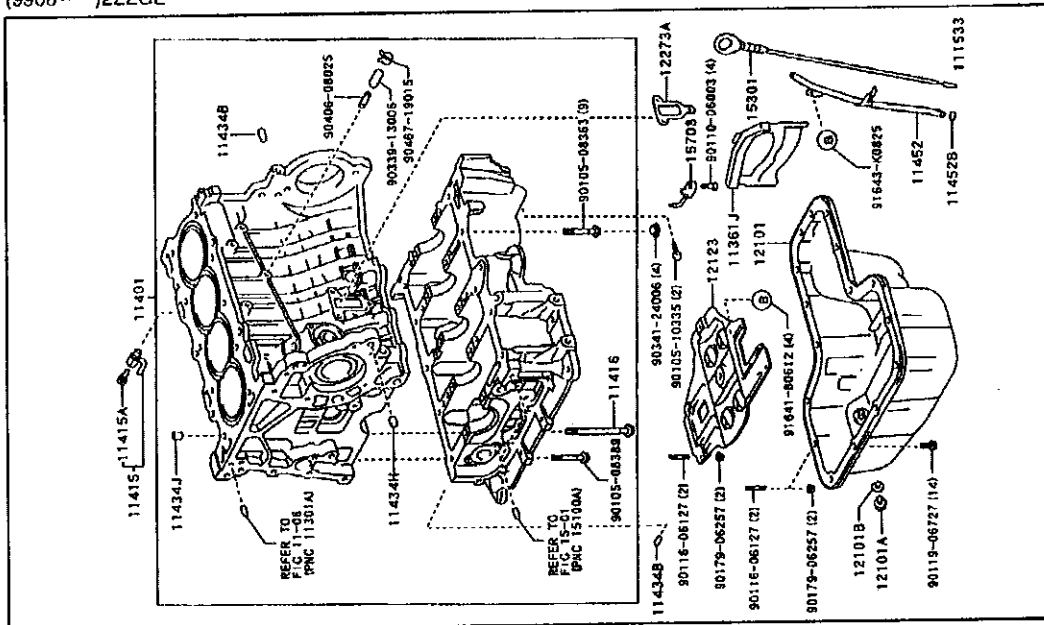

Fig. 1701/ Manifold
(9908-)2ZZGE

