

GReddy Turbo Kit

HONDA S2000 AP1 (2000-2003 F20C) T518Z 8cm²

HONDA S2000 AP1 (F20C) T518Z 8cm²

Installation Manual

Please read the entire manual before installing this kit.

Application:

Make	Model	Chassis	Year
HONDA	S2000	AP1	00~03

- This **GRReddy Turbo Kit** is designed only for the vehicles specified above.
- Premium grade gasoline (91 octane or higher) is required with this Kit.
- Make sure that the vehicle is not equipped with any ECM upgrade chips.
- Use of **GRReddy Racing Spark Plugs ISO #8** or NGK plugs (colder than factory) is recommended with this kit.

Important

- This installation should only be performed by a trained specialist who is very familiar with the automobile's mechanical, electrical and fuel management system.
- If installed by an untrained person, it may cause damage to the kit as well as the vehicle.
- GRReddy Performance Products Inc. is not responsible for any damage to the vehicle's electrical system caused by improper installation.
- This kit is for off-road use vehicle only which may never be driven on a public highway

※ **The following parts are necessary for proper installation of the kit.**

Honda Genuine Parts:

• Part Name	<u>Gasket, Exhaust manifold</u>	P/#	<u>18115-PCX-004</u>	Quantity	<u>1</u>
• Part Name	<u>Gasket, Silencer</u>	P/#	<u>16705-PD1-003</u>	Quantity	<u>1</u>
• Part Name	<u>Sealing Washer</u>	P/#	<u>90428-PD6-003</u>	Quantity	<u>1</u>

1. Parts List

1.	Turbocharger T518Z—10cm ² P555		1
2.	Exhaust Manifold	(SUS42. 7φ)	1
3.	Downpipe	(Steel 60φ)	1
4.	Intercooler Spec-V T-28C		1
5.	Suction Pipe S—1	(Aluminum 60φ)	1
6.	Compression Tube	C—1 (Aluminum 50φ)	1
7.	"	C—2 (Aluminum 60φ)	1
8.	"	C—3 (Aluminum 60φ)	1
9.	"	C—4 (Aluminum 60φ)	1
10.	"	C—5 (Aluminum 70φ)	1
11.	Injectors(S2000 Use only 550cc×4、O-ring Large×8、O-ring Small×4、Spacer×5)		1 set
12.	Injector Harness		4
13.	Fuel Pump Kit (Walbro 255lph, S2000 pump kit)		1
14.	E-manage Ultimate (TK US--AP1)		1
15.	"	Plug-in harness H—8 (AP1 Specific)	1
16.	AIRINX	AY—MB	1
17.	"	Hose Adapter M60	1
18.	Air Diversion Panel (Aluminum t=1. 0)		1
19.	Oil Filter Relocation Kit	Engine Block Attachment	1
20.	"	Oil filter Attachment	1
21.	"	Center Union M20 P1. 5—AN10 (For Block side)	1
22.	"	Center Union 3/4UNF16—AN10 (For Filter side)	1
23.	"	Side Union AN10	2
24.	"	O ring(For attachment)	1
25.	"	O ring(For Center Union)	2
26.	"	O ring(For Side Union)	2
27.	"	Oil Line Hose A 45° — 45° 195mm	1
28.	"	" B 45° —90° 270 mm	1
29.	"	1/8PT Plug Union	4
30.	"	M14 plug bolt (O ring attachment)	1
31.	"	Corrugated Tube 300mm	1
32.	"	GReddy Oil Filter OX—02	1
33.	"	Stay	1

34.	Oil Pressure Hose	SUS	400mm		1
35.	"	Union fitting	1/8PF—M10	P1. 25	1
36.	"	Union fitting	1/8PT—1/8PT		1
37.	"	90° Union fitting	1/8PT—1/8PF		1
38.	"	3 Way Fitting			1
39.	"	Copper Washer	10. 5 φ × 18 × 1. 0		1
40.	Oil Return	Flange Tube	16 φ		1
41.	"	Hose Union	16 φ—M14	P1. 5	1
42.	"	Copper Washer	14 φ × 19 × 2. 0		1
43.	Vacuum Hose		4 φ × 1200mm	(Actuator, Pressure sensor, Air solenoid)	1
44.	Rubber Hose		7. 5 φ × 300mm	(Water Line)	1
45.	"		12 φ × 430mm	(Blow-by)	1
46.	"		15 φ × 340mm	(Oil return)	1
47.	"		18 φ × 400mm	(Air-pump)	1
48.	Silicone Hose		50 φ × 70mm		1
49.	"		60 φ × 70mm		2
50.	"		70 φ × 70mm		1
51.	"		50 φ—60 φ	Reducer	1
52.	"		60 φ—70 φ	Reducer	1
53.	Hose Band	8 φ	Tridon	#4	2
54.	"	12 φ	Tridon	#8	2
55.	"	15 φ	Tridon	#10	2
56.	"	19 φ	Tridon	#12	3
57.	"	50 φ	Tridon	#32	3
58.	"	60 φ	Tridon	#36	7
59.	"	70 φ	Tridon	#44	3
60.	Gasket	Turbo	IN		1
61.	"	Turbo	OUT		1
62.	"	Suction Tube	Flange		1
63.	"	Compression Tube	Flange		1
64.	"	Downpipe	(Ring 65 φ)		1
65.	"	Oil return	Gasket		1

66.	Bracket	Intercooler								1
67.	"	Air pump								1
68.	"	Vacuum Tank								1
69.	"	Air Diversion Panel								1
70.	*No longer used in this kit*									
71.	"	Pressure Sensor								1
72.	Pressure Sensor Adapter									1
73.	Hose Union 5 ϕ – 1/8PT									1
74.	19 ϕ Hose Union									1
75.	Rubber Mount									2
76.	Clip									3
77.	Air Duct 50 ϕ \times 1000mm									1
78.	Thermo Cloth 100 \times 1000mm									2
79.	Zip Tie 100mm (Black)									10
80.	Zip Tie 200mm (Black)									10
81.	M4 \times 18mm	P0.7	+ Head	B	–	–	N	(Pressure Sensor)		2
82.	M5 \times 12mm	P0.8	+ Head	B	–	–	N	(Sec. Air Solenoid Valve)		1
83.	M6 \times 15mm	P1.0	Stainless	B	S/W	–	–	(Oil filter re-locator stay)		2
84.	M6 \times 15mm	P1.0	Stainless	B	S/W	F/W	–	(Oil Return, Baffle plate stay)		3
85.	*No longer used in this kit*									
86.	M6 \times 25mm	P1.0	Stainless	B	S/W	F/W	–	(Pressure Sensor Stay)		2
87.	M6 Flange Nut	P1.0	Steel					(Rubber Mount)		2
88.	M8 \times 15mm	P1.25	Stainless	B	S/W	–	–	(Oil filter re-locator stay)		2
89.	M8 \times 15mm	P1.25	Stainless	B	S/W	F/W	N	(Air pump, I/C, I/C stay, C-4)		6
90.	M8 \times 20 mm	P1.25	Stainless	B	S/W	F/W	–	(Turbine Compressor IN/OUT)		4
91.	M8 \times 30 mm	P1.25	Stainless Stud	B	S/W	–	N	(Turbine Exhaust IN/OUT)		9
92.	M10 \times 20mm	P1.25	Stainless	B	S/W	F/W	N	(Downpipe Stay)		1

Parts List



1



2



3



4



5



6



7



8



9



10

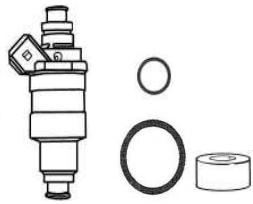

11



12



13



14



15

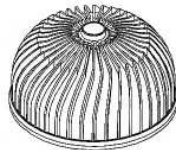

16

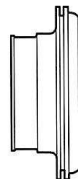

17



18



19



20



21



22



23



24



25



26



27, 28



29



30



31



32



33

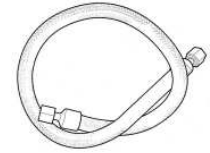

34

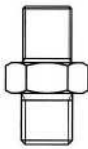

35, 36

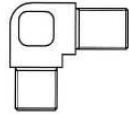

37

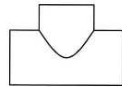

38

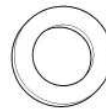

39



40

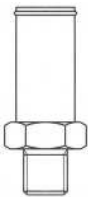

41



42

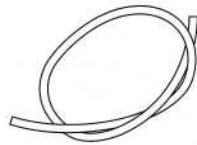

43

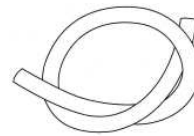

44-47



48-50



51, 52



53-59

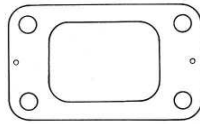

60



61

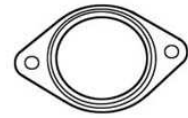

62

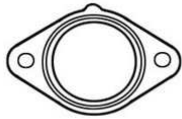

63



64



65



66



67



68



69

No longer in use

70



71



72

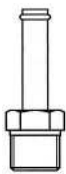

73



74



75



76



77

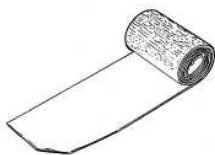

78



79, 80

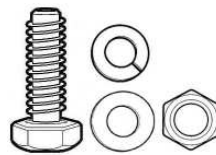

81-92

2. Removal of Stock Parts

When removing the stock parts, make sure you read over the factory repair manual for the proper procedures.

- 2-1 Disconnect the battery. Write down the radio presets and be sure to have the code for the factory radio.
- 2-2 Relieve the fuel pressure in the fuel system. (see factory repair manual for detail procedure).
- 2-3 Drain the engine oil.
- 2-4 Remove the Air cleaner assembly with intake tube, and breather hose.
- 2-5 Remove the exhaust manifold and heat shields.
- 2-6 Remove the two engine under covers and the front bumper.

3. Kit Installation

3-1 Turbo Installation

- (1) Before installing the turbo charger, make sure to insulate the surrounding components with the provided thermo cloth. Since the area around the exhaust manifold will get very hot, it is important to insulate the surrounding components to prevent fire/heat damage.



- (2) Install the **#91** studs on the exhaust housing. Install the **#35** union with **#39** brass washer on the top side of the turbo as shown.

〈Parts used: 35, 39, 91〉

- (3) Install the **#91** studs onto the exhaust manifold, then attach the turbo to the manifold. Be sure to use the provided gasket between the turbo and manifold **#60**.

〈Parts used: 1, 2, 60, 91〉

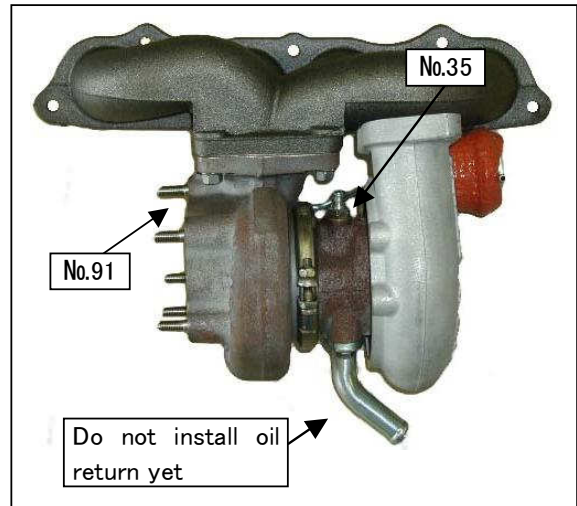

- (4) Unclip the plug going to the Vtec Solenoid as shown by the arrow in the image. Temporarily remove the OEM intake support bracket that is attached to the passenger side of the chassis. Pass the turbocharger assembly through this space from the front of the engine towards its destination. Be cautious not to damage the turbocharger or any engine parts during this process, as it is a close fit.

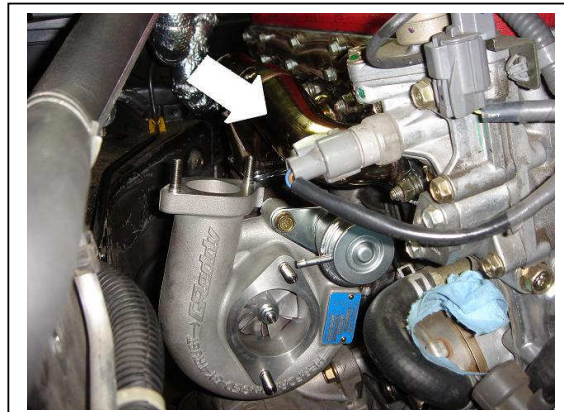

- (5) Use the new OEM exhaust manifold gasket when installing the turbocharger assembly onto the motor.
- (6) Tighten the exhaust turbocharger assembly onto the cylinder head using the OEM nuts.
- (7) Install **#40** oil return tube with **#65** gasket on the bottom side of the turbo with the provided **#84** bolts as shown in section 3- 3.

〈Parts used: 40, 65, 84〉

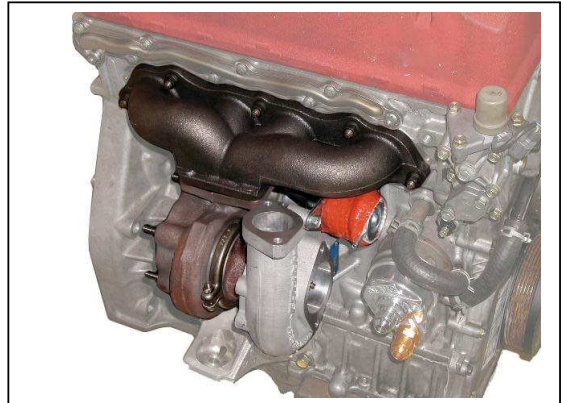

3-2 Oil Pressure Switch

- (1) Remove the factory oil pressure switch. Install **#36** union into the **#38** three way fitting. Proceed to install into the block where the oil pressure switch was located.

*Be sure to use Teflon tape on each side of the union.

〈Parts used: 36, 38〉

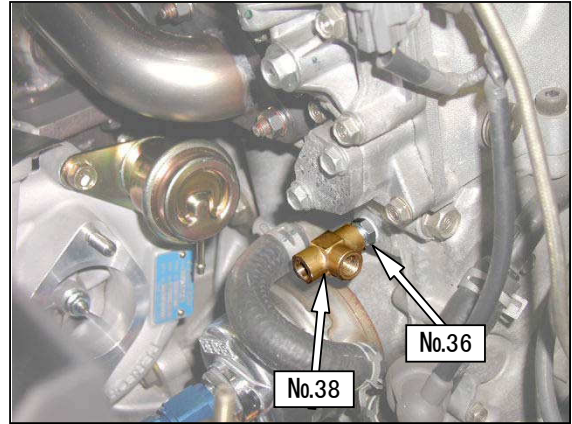

- (2) Install the factory oil pressure switch to the part of the three way fitting facing the front of the car.

※ Install the 90° fitting **#37** facing upwards as shown.

※ Be sure to use Teflon tape on the 90° fitting (3 way fitting side ONLY) and on the oil pressure switch.

〈Parts used: 37〉

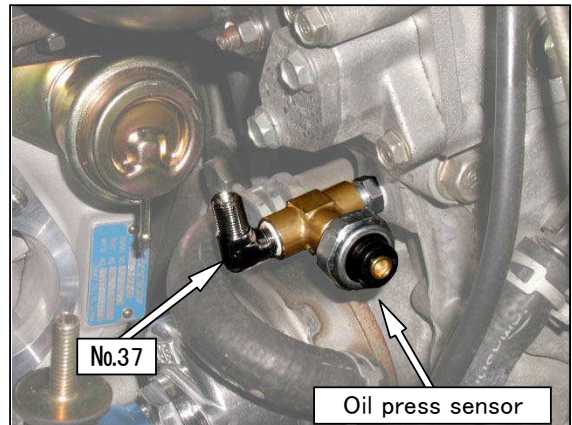

3-3 Oil Filter relocation

- (1) Install Unions **#21** & **#23** into Oil Block adapter **#19**. Make sure to use the provided O rings **#25** & **#26** on the unions and **#24** on the adapter. Install union plugs **#29** into the adapter as shown.

※ Lubricate the o-ring and the thread to prevent any cross threading and damaging the o-ring.

※ Apply Teflon tape on the 1/8PT plugs and make sure not to over torque.

〈Parts used: 19, 21, 23, 24, 25, 26, 29〉

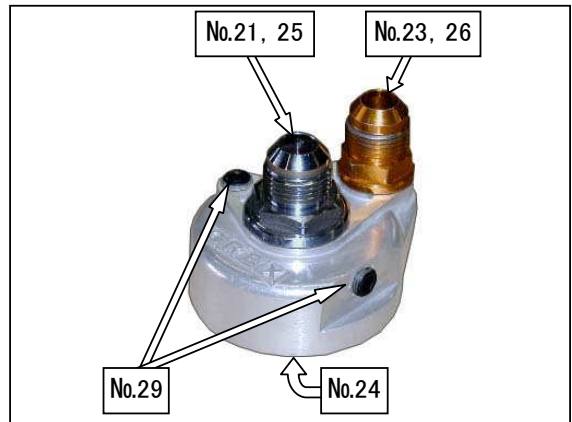

- (2) Install the adapter as shown. The **#23** union should be facing in the 7 o'clock position, tighten the **#21** union so the adapter is secured in this position.

※ Lubricate the O-ring and the thread to prevent any cross threading and damaging the o-ring.



- (3) Install **#29** union plugs in the 2 locations in adapter **#20** as shown. Install union **#22** with O ring **#25** and union **#23** with O ring **#26** in the adapter as shown. Install plug bolt **#30** as shown.

- ※ Lubricate the o-ring and the thread to prevent any cross threading and damaging the o-ring.
- ※ Apply Teflon tape on the 1/8PT plugs and make sure not to over torque.

〈Parts used: 20, 22, 23, 25, 26, 29, 30〉

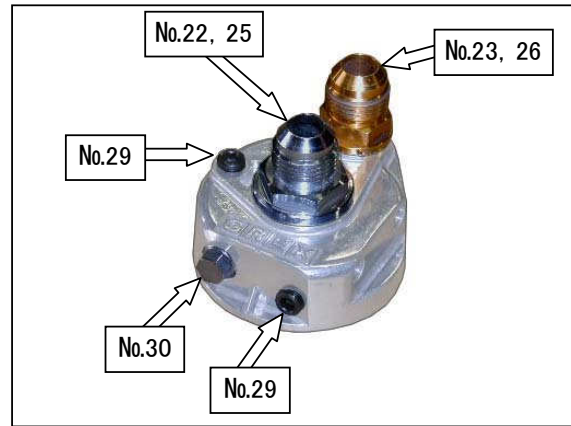

- (4) Attach bracket **#33** to the adapter using bolts **#88**. Attach the oil filter to the adapter, be sure to use a little oil on the filter seal.

- ※ Lubricate the O-ring on the filter.

〈Parts used: 32, 33, 88〉

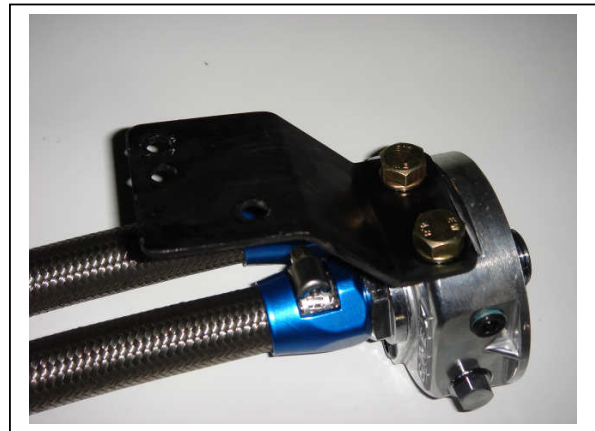

- (5) Attach the filter adapter to the passenger side shock tower using the provided M6 bolts **#83**.

〈Parts used: 83〉

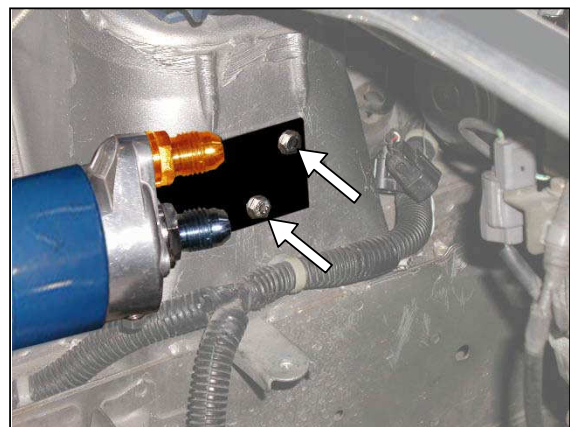

(6) Connect oil hoses #27 (A) & #28 (B).

- Oil line hose **A** goes between the center unions.
Where the 90 degree fitting is on the filter side, and the 45 degree fitting on the engine side.
- Oil line hose **B** goes between the side unions.
Where the 45 degree fittings are on each side.
- ※ Use the corrugated tube (#31) to cover any part of the oil lines that might make contact with any part of the chassis or the other oil line.
- ※ Refer to the Images to reference where each end of the hoses should go.

〈Parts used: 27, 28, 31〉

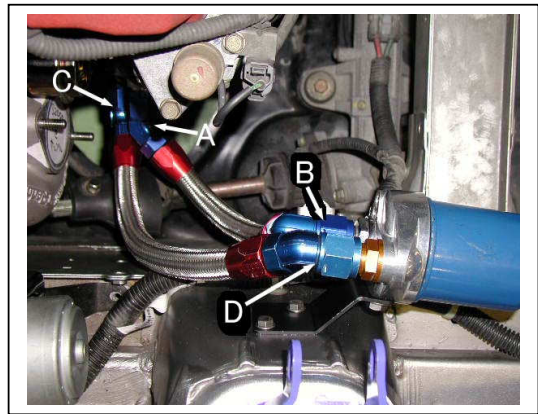
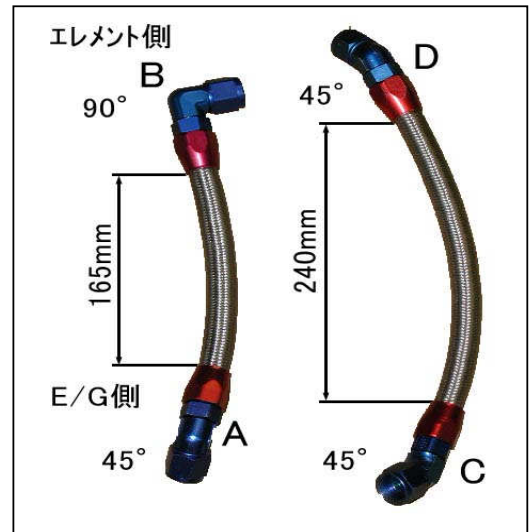

Optional Sensor Installation Instructions

Engine Block side

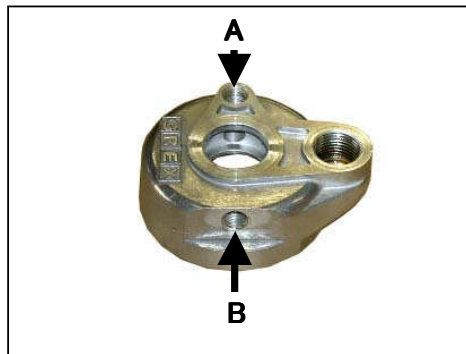

Oil filter side

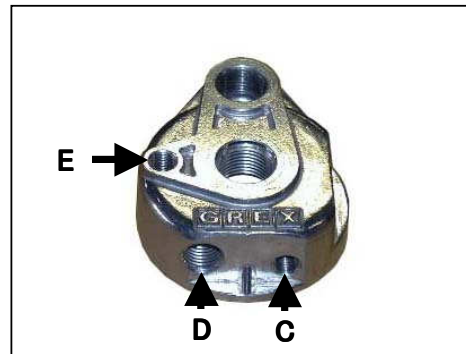

- Sections A, B, E (1/8PT) ... able to measure oil temperature and oil pressure.
- Section C (1/8PT) ... **GREddy** The electrical type warning meter temperature sensor fits here.
- Section D (M14 x P1.5) ... Mechanical type temperature sensor fits here.

3-4 Oil Feed Line installation

- (1) Install the **#34** oil feed line as shown, connecting one end to the 90° fitting from the oil pressure switch and the other to the union on the top side of the turbo. Bend the line to make room for the compression pipe on the turbo. Be careful not to kink the line. Be sure that the oil line does not make contact with any other parts.

〈Parts used: #34〉

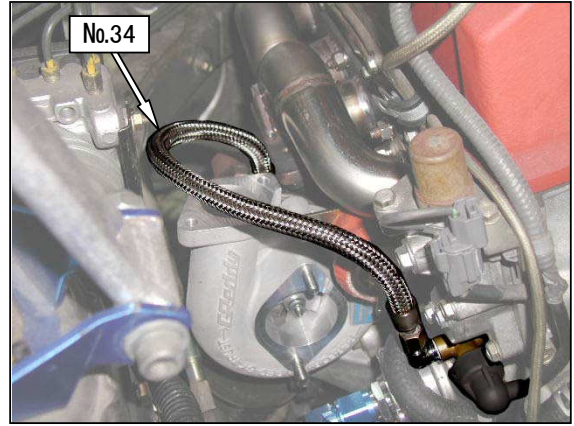

- (2) Remove the factory oil drain bolt and crush washer. Using **#41** Union and **#42** brass washer, install where the factory oil drain bolt was located.

〈Parts used: 41, 42〉

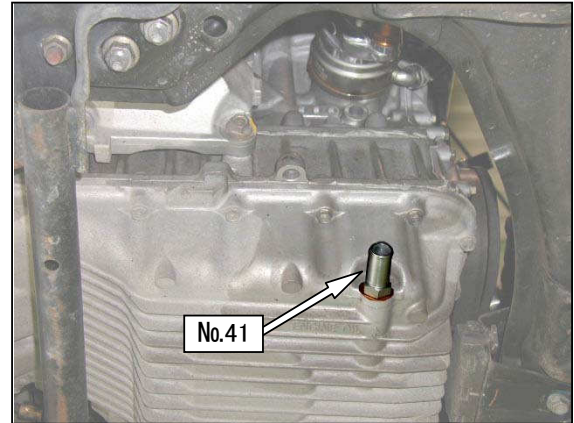

- (3) Cover the **#46** 15 φ hose with thermo cloth (**#78**) and connect it from the oil return flange pipe to the oil return union on the oil pan. Use **#55** hose bands on each end to secure the hose from leaking oil.

〈Parts used: 46, 55, 78〉

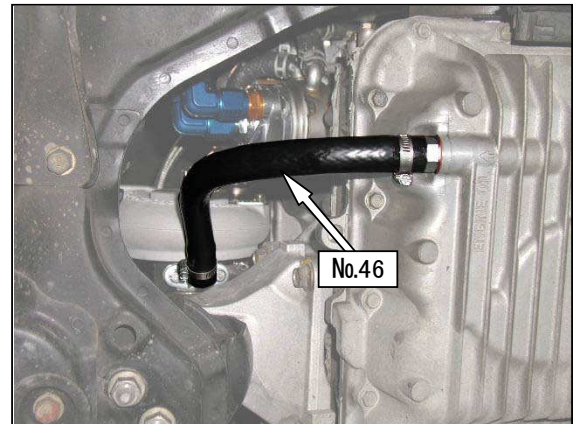

3-5 Downpipe Installation

- (1) Disconnect and remove the O2 sensor from the factor exhaust manifold and install onto the provided downpipe. Install the **#64** downpipe gasket on the end of the downpipe, which connects to the catalytic converter.

〈Parts used: 3, 64〉

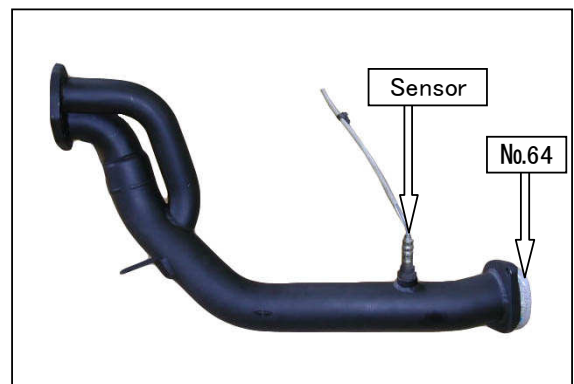

- (2) Install the downpipe to the turbine housing using **#61** turbine gasket, secure with provided nuts and lock washers.
- ※ Use factory spring bolts to attach the downpipe to the catalytic converter.

〈Parts used: 61〉



- (3) Use the factory exhaust manifold bracket to support the downpipe.
- ※ Use the factory bolt on the transmission side, use **#92** nut/bolt to secure the downpipe to the bracket.

〈Parts used: 92〉

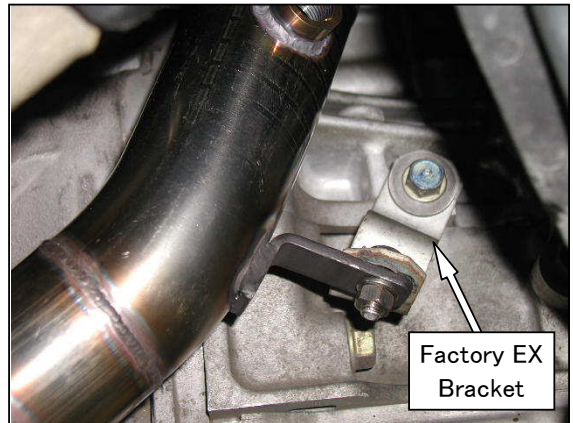

3-6 Vacuum Piping

- (1) Remove the breather/coolant pipe. Have a towel or rag ready to catch the coolant that will spill out from the port below the throttle body.



- (2) Use **#44** 8 ϕ hose to connect the coolant passages as shown. Secure the ends with the provided **#53** hose clamps.

〈Parts used:44, 53〉



- (3) Remove the secondary air control solenoid valve hoses from the hard lines and take note which hose goes to which hard line. Attach the secondary air control solenoid valve to the provided bracket #68 using the provided M5 nut/bolt #82, then install the bracket onto the chassis cross bar using the OEM bolt.

〈Parts used: 68, 82〉

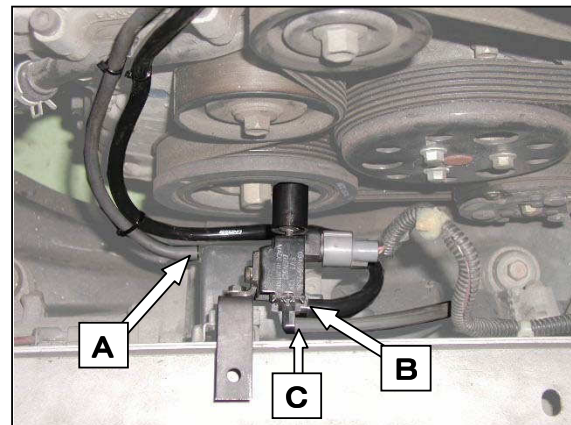
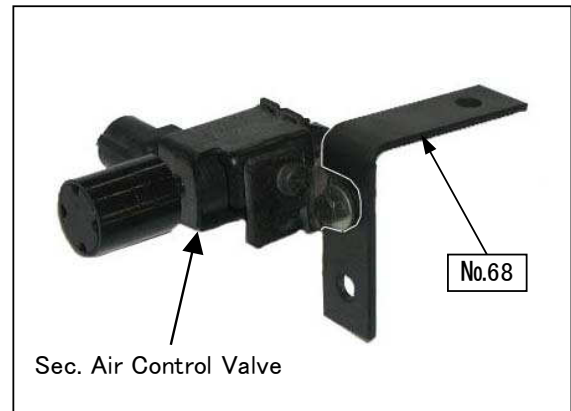

- (4) Connect the 5 ϕ hose routed under the fuel pipe to the vacuum tank IN side **A** (hose with check valve). Also connect the lower 5 ϕ pipe to the air control solenoid valve **B** using the provided hose (700mm cut).

※ Make sure the hoses are secured to prevent them from touching the engine belts.

〈Parts used: 43, 80〉



- (5) Secure the hoses with cable ties.
- ① **A** 5 ϕ hose at the upper pipe and check valve.
 - ② Intake Manifold and lower 5 ϕ pipe.

〈Parts used: 80〉

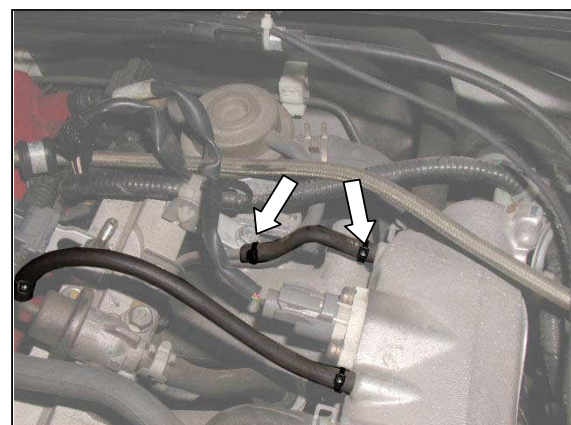

3-7 Intercooler Installation

- (1) Attach bracket **#66** to the radiator support as shown using the existing hole and the provided hardware **#89**.
※ Longer side of the bracket attaches to the radiator support.

〈Parts used: 66, 89〉

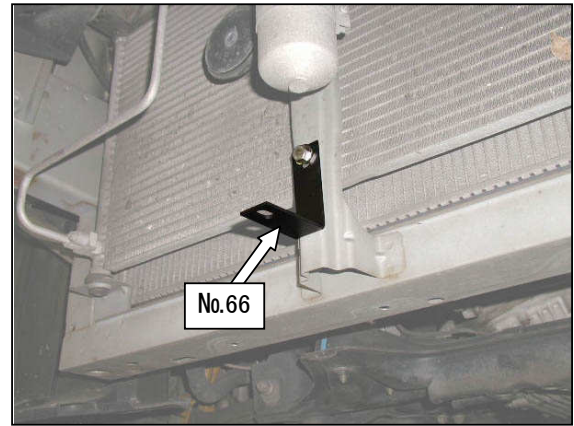

- (2) Intercooler mounting.

Left and Right Mounting Brackets Use the existing hole on the underside of the frame as shown for the intercooler mounting brackets. Use the provided nuts/bolts **#89** to secure the intercooler in place.

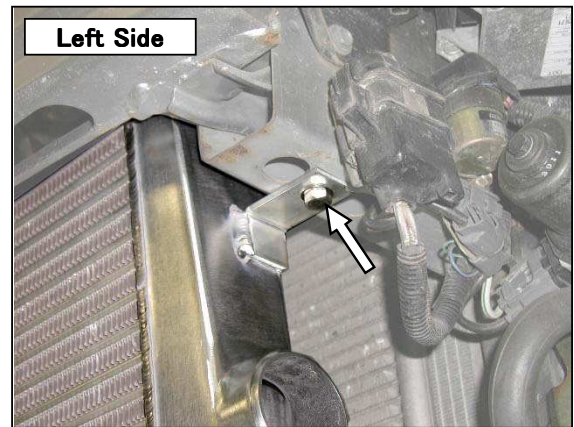

Bottom Mounting Bracket Intercooler and bottom mounting bracket. Use provided nuts/bolts **#89** to secure the intercooler to the bracket.

〈Parts used: 4, 89〉



3-8 Air Pump Relocation

- (1) Remove the lower mounting bolt from the air pump, place the **#67** bracket as shown. Use the factory bolt in the same location it was taken to secure the bracket down. Use the provided **#89** nuts and bolts to relocate the pump towards the front of the car, mounting it to the end of the **#67** mounting bracket as shown.

〈Parts used: 67, 89〉

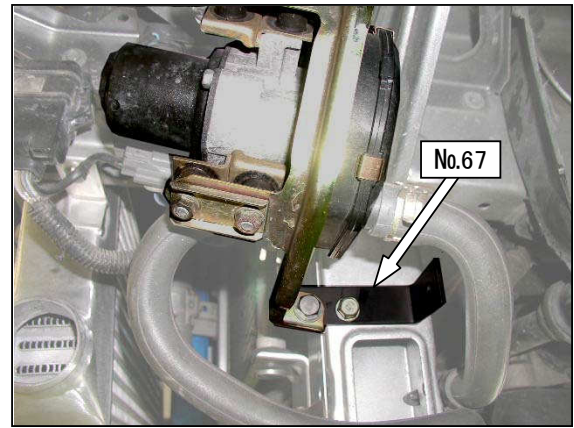

- (2) The air pump IN hose is the upper hose and the OUT hose is the lower hose. Unclip the stay on both hoses and position the IN hose so it sits directly below the OUT hose as shown. Remove the original stay that was holding the IN hose to make room for the intercooler piping. Re-clip the OUT hose once the IN hose is positioned below it.

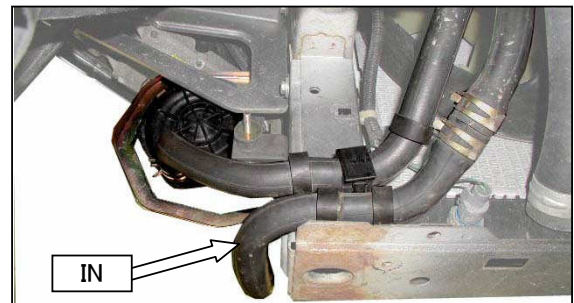
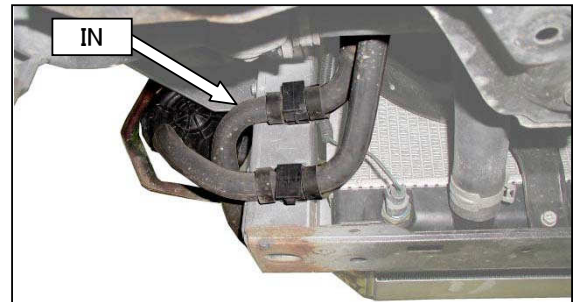

3-9 Suction Pipe Installation

- (1) Install the **#75** rubber vibration mount onto the factory intake mounting bracket as shown.

〈Parts used: 75〉

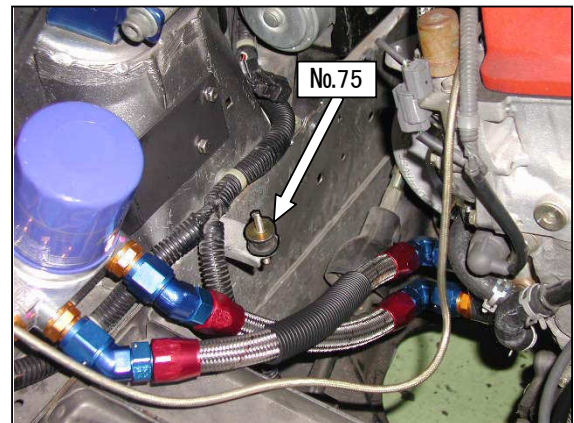

- (2) Install suction pipe **S-1** to the compressor housing using the provided **#62** gasket. Be sure that the bracket on the pipe is positioned onto the rubber vibration mount previously installed. Secure **S-1** at the compressor housing with the provided **#90** hardware. Secure **S-1** at the bracket and vibration mount with the provided **#87** nut.

〈Parts used: 5, 62, 87, 90〉

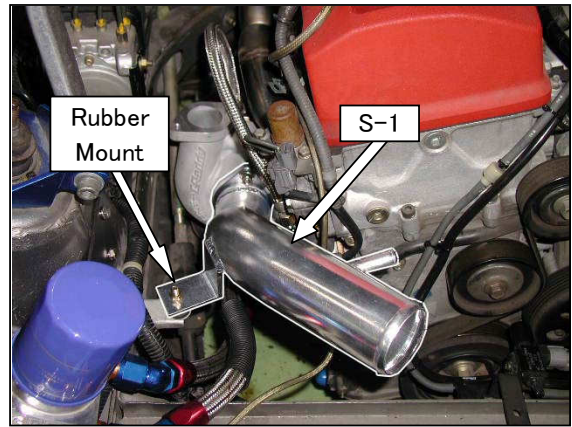

Install the 12 ϕ oil resistant hose **#45** from the valve cover breather nipple to the nipple on the **S-1** suction pipe. Use provided hose clamps **#54** to secure both ends of the hose.

〈Parts used: 45, 54〉

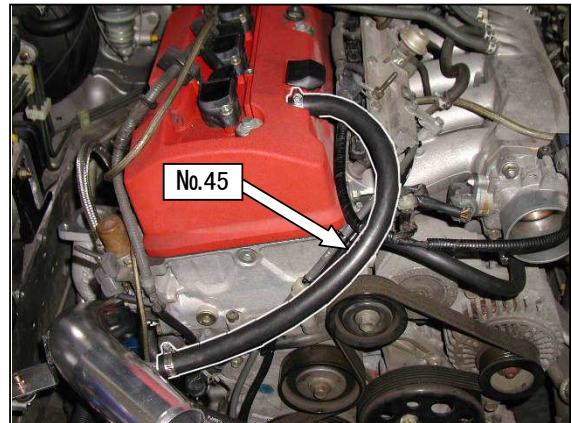

- ※ Install the provided 19 ϕ hose (**#47**) to the air pump OUT hose using union **#74**. Secure the other end of the hose to the suction pipe **S-1**. Use provided **#56** hose clamps to secure both ends of the hose, as well as the end of the air pump OUT hose (3 hose clamps used total).

〈Parts used: 47, 56, 74〉

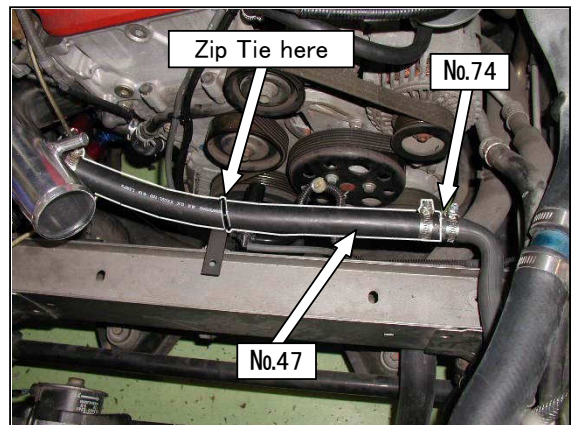

3-10 Intercooler Piping

- (1) Install **#75** rubber vibration mount to the factory hole on the chassis as shown.

〈Parts used: 75〉

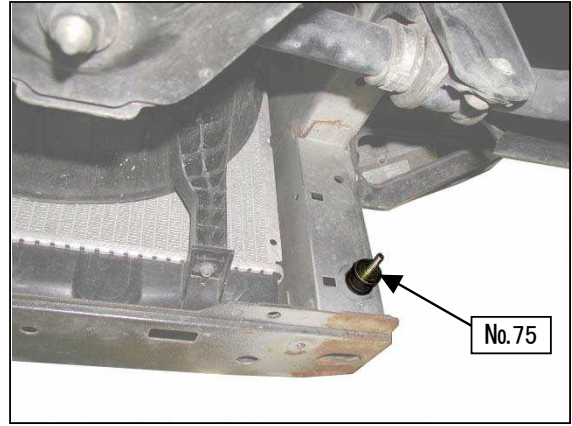

- (2) Install hose fitting $5\phi - 1/8PT$ **#73** to compression pipe C-1.

※ Be sure to use Teflon tape on the threads of the hose fitting.

〈Parts used: 6,73〉

- (3) Cut provided vacuum hose to 200mm and route it between the actuator and C-1 and secure the hose with zip-ties.

〈Parts used: 43, 80〉

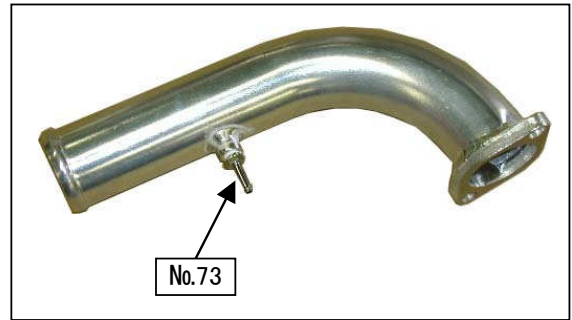

- (4) Install Compression tube C-1, C-2, C-3 from turbo to intercooler inlet as shown. Use C-1 Gasket **#63**.

Compression Tube C-2

Using the provided **#87** flange nut, secure the tube to the vibration rubber stub as shown.

Compression Tube C-3

The shorter straight side is intercooler side.

〈Parts used No.6,7,8,48,49,51,57,58,63,87,90〉

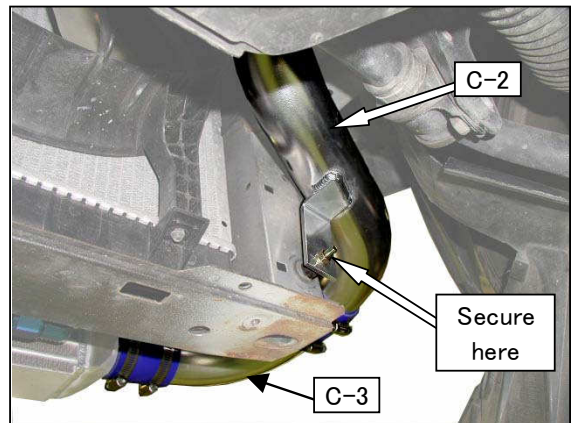
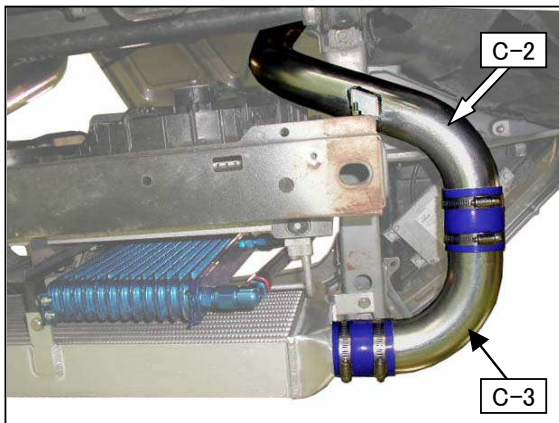
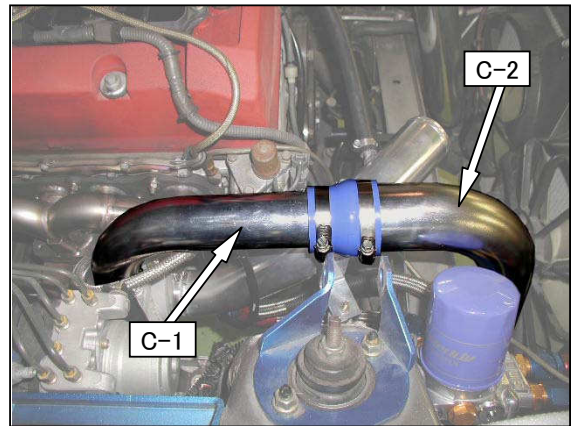

- (3) Install the Compression tubes C-4, C-5 from intercooler outlet to the throttle body as shown.

Compression Tube C-4

Secure the bracket to the air pump bracket with the provided nut/bolt #89.

Compression Tube C-5

Longer straight side connects to throttle body.

- ※ Route the tube so that it would not hit or rub up on the air pump bracket or the electric fan.

⟨Parts used No.9, 10, 49, 50, 52, 58, 59, 89⟩

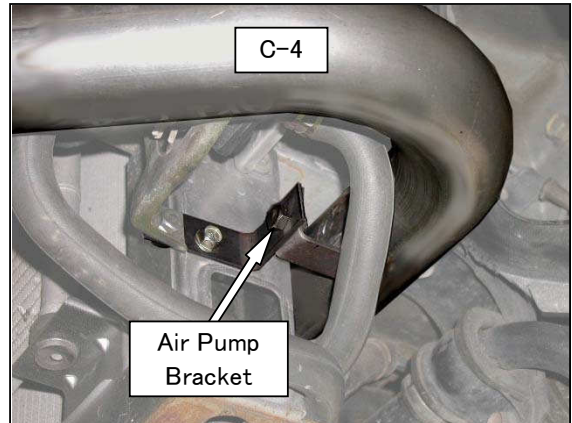
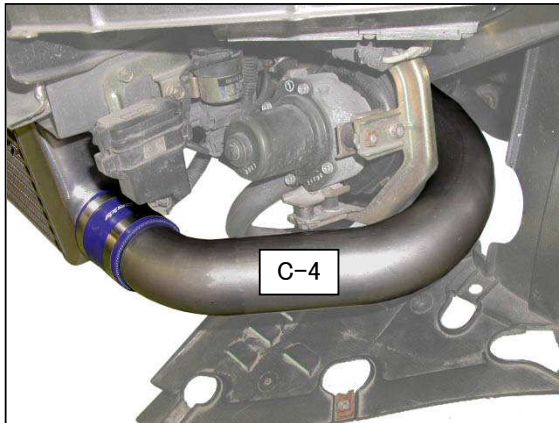
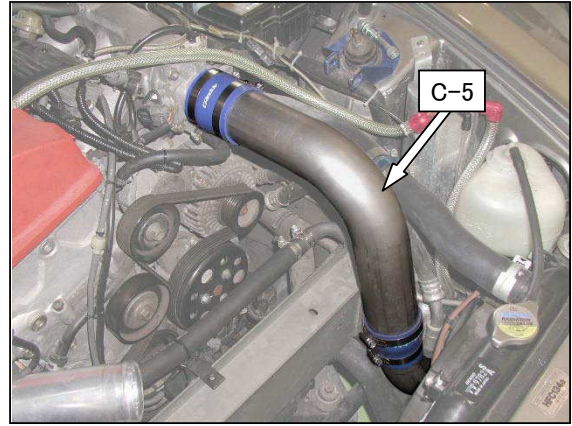

3-11 Baffle Plate Installation

- (1) Remove the factory intake manifold bracket and install the #69 stay as shown using hardware #84.

⟨Parts used: 69, 84⟩

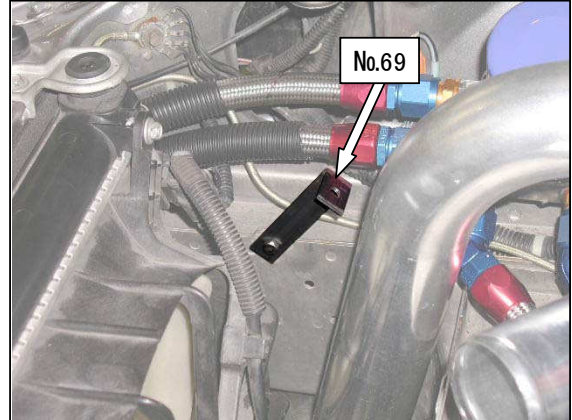

- (2) Insert a zip tie through the baffle plate as shown in the picture. Remove the right side radiator bracket and install the baffle plate. Use the provided clips to secure the baffle plate, to the bulkhead, upper frame, and vacuum tank bracket (3 points).

⟨Parts used: 18, 76, 80⟩

- ※ Position the baffle plate and vacuum tank bracket so there is clearance between the plate and the compression tube and radiator.

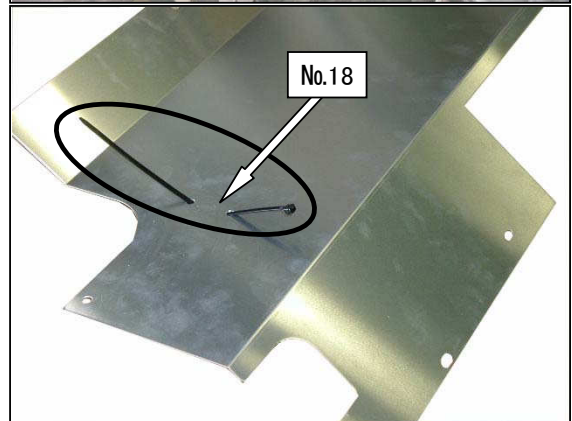

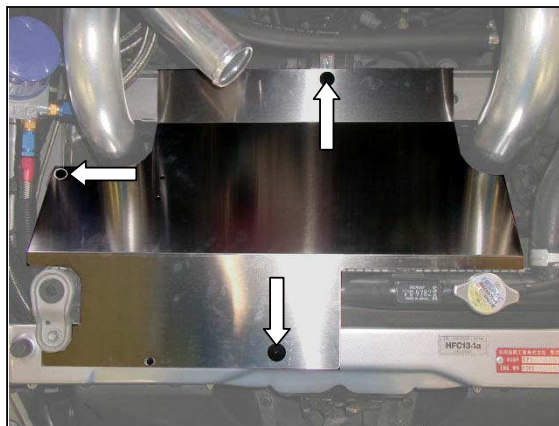

3-11 Airinx Installation

- (1) Remove the top bolt on the Airinx kit, remove the outer frame, then the filter. Install the rubber hose adapter to the base of the Airinx kit.

〈Parts used: 16, 17〉

- (2) Reassemble the Airinx filter, hand tighten the top bolt.

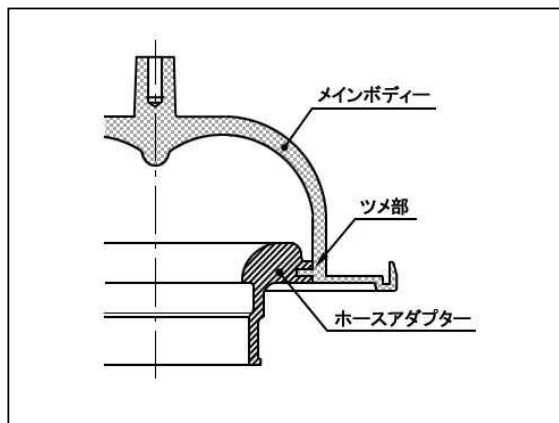

- (3) **3-10(2)** Install the Airinx filter onto the suction pipe S-1, secure it with hose band #58.

〈Parts used: 58〉

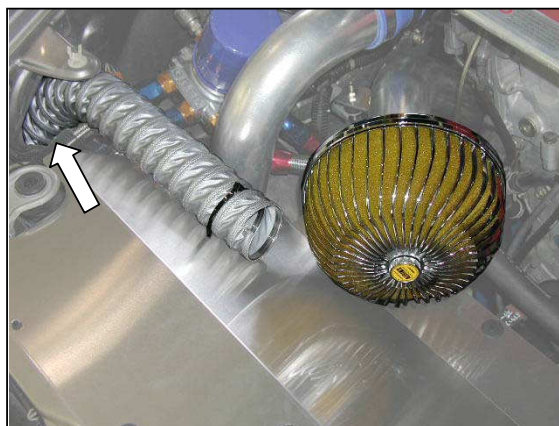

3-12 Factory Heat shield Modification

- (1) Cut the factory heat shield as shown.
 - (2) Mount the modified heat shield back onto the chassis using factory bolts.
- ※ Apply paint or rust stop to the edge of the heat shield where it was cut to keep the exposed raw metal from rusting.



Note Use the proper safety equipment when modifying the heat shield.

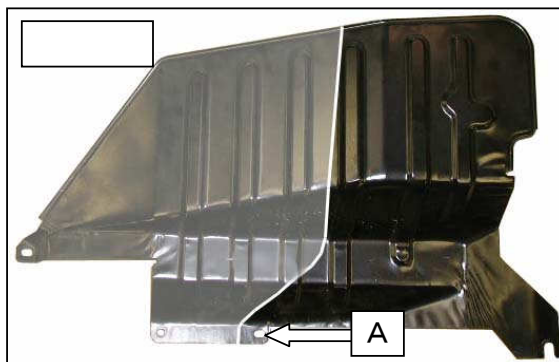

3-13 Injector Installation

- (1) Apply a light amount of silicon grease to the O rings on each injector. The smaller O ring at the top and the two larger O rings at the base.
〈Parts used: 11〉

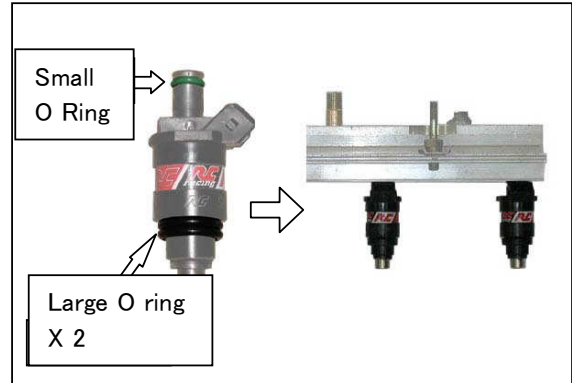

- (2) Remove the factory fuel rail. Be careful when removing the fuel pulsation dampener and the fuel pressure regulator. Be careful not to lose the seals on both sides of the fuel pulsation dampener. Have a rag to soak up the extra fuel that will leak out.

- (3) Install the injectors to the factory fuel rail.

- ※ Be careful not to damage the O rings when inserting the injectors into the fuel rail. Slowly insert the injectors, being sure to keep the same orientation of the injectors as factory.

- (4) Remove the 3 Factory studs shown and insert a spacer onto each stud between the stud and the intake manifold. Reattach the studs.
〈Parts used: 11〉

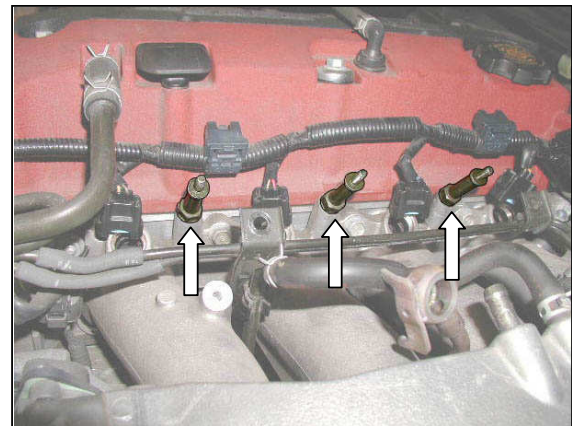

- (5) Attach the plug and play injector harness clips to the factory injector clips.

- ※ Make sure the clips snap into place to make a good connection.

〈Parts used: 12〉

- (6) Insert the fuel rail with the injectors installed into the intake manifold. Be sure each injector is seated properly and that none of the O rings have fallen off or ripped.

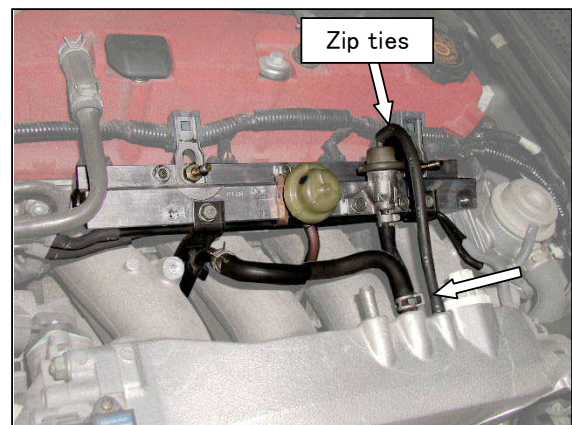

- (7) Use the New silencer gasket and sealing washer in place of the old gasket and washer on the fuel pulsation dampener during reinstallation.

Use a zip tie on both ends of the vacuum hose that goes from the fuel pressure regulator to the intake manifold.

〈Parts used: 80〉

- (8) Use the provided spacers under the brackets marked **A** in the image (use on the intake manifold side). Use the provided extended bolt in place of the factory bolt to accommodate for the added length.

⟨Parts used: 11, 86⟩

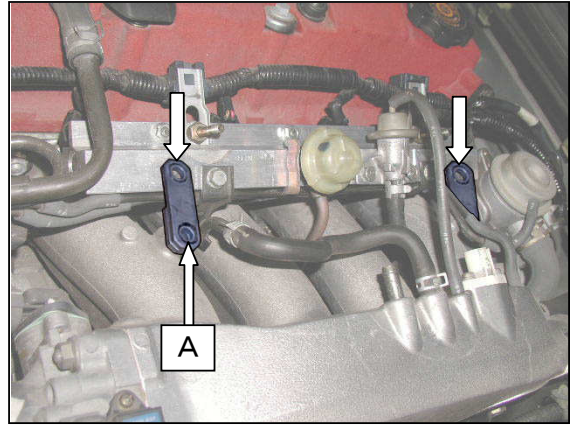

3-14 Factory Pressure Sensor Relocation

- (1) Remove the factory pressure sensor and replace it with the provided pressure sensor adapter.
 ※ Use factory hardware for installation.

⟨Parts used: 72⟩

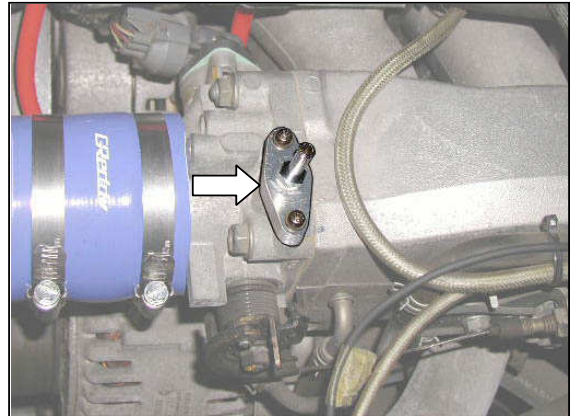

- (2) Attach the factory pressure sensor to **#71** bracket. Secure using **#81** nuts/bolts.

⟨Parts used: 71,81⟩

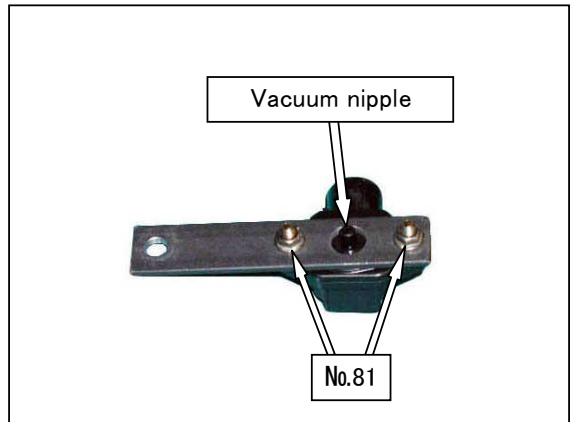

- (3) Attach the sensor and bracket to the fuel rail bracket pictured.
 (4) Attach the provided vacuum hose from the pressure sensor adapter to the pressure sensor. Secure both ends of the hose with zip ties.

⟨Parts used: 43,79⟩

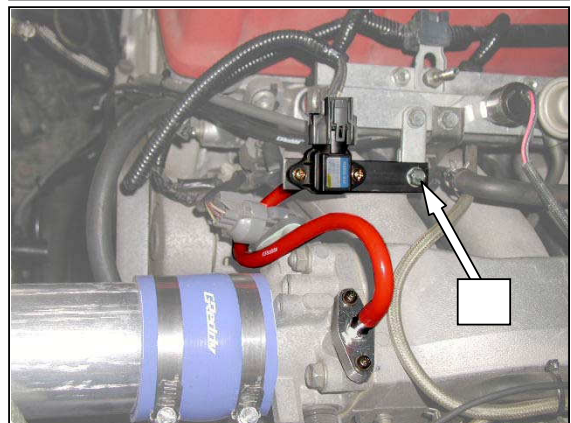

3-15 Walbro Fuel Pump Installation

- (1) Remove the factory spare tire from the trunk.
- (2) Remove the holding tray located behind the seats. Remove the pushpins securing the tray. After removing the pushpins, slide the tray out through the trunk.
- (3) Remove the fuel pump cover secured by 3 screws.
- (4) Disconnect the fuel feed and return lines. Be careful not to damage the connectors when disconnecting the fuel lines.
- (5) Disconnect the electrical connector.
- (6) Remove the eight screws securing the fuel pump assy. Carefully remove the fuel pump assy. Use caution to prevent damage to the fuel level sender.
- (7) Disconnect the electrical connector on the fuel pump.
- (8) Disconnect the plastic retaining clip on the bottom of the pump.
- (9) Use pliers to slide the spring clamp on the fuel filter side of the hose. Remove the fuel pump and hose from the fuel filter. It is recommended to change the fuel filter if you have not already.
- (10) Install the included fuel filter to the bottom of the fuel pump with the small retaining clip.
- (11) Attach the included hose to the top of the fuel pump and insert pump back into the fuel filter Assy. The hose may need to be trimmed to fit. Use the included hose bands to secure the fuel hose to the pump and fuel filter Assy.
- (12) Secure the fuel pump to the case with the plastic retaining clip removed in (8) and connect the electrical connector to the fuel pump.
- (13) Re-install the fuel pump/filter and removed components in reverse order.

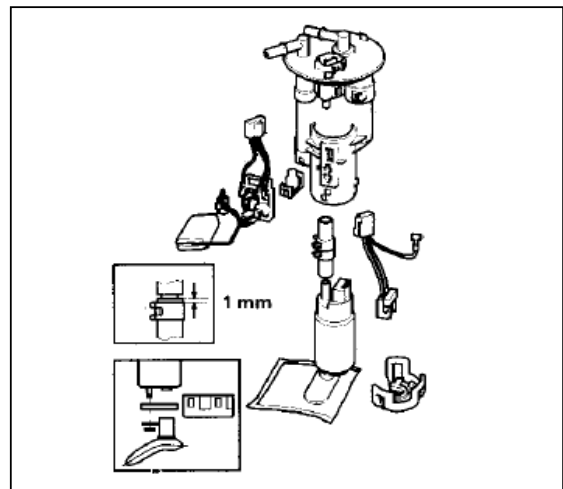
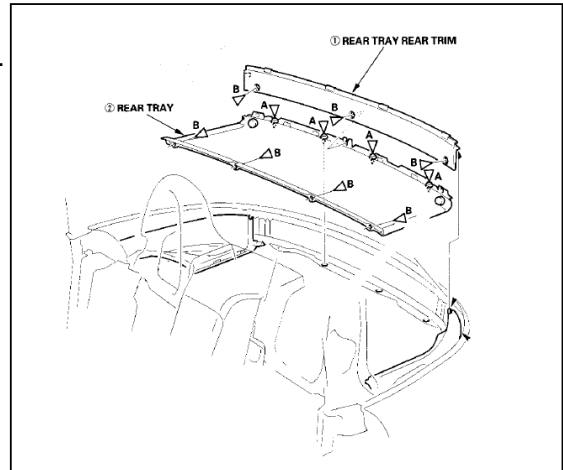

(Parts Used: 13)

3-16 Intake Duct Routing

- (1) Remove the OEM air Diversion Panel.
- (1) Position and route the intake ducting #77 as shown.
- (2) Use the provided zip ties to secure the ducting onto the GReddy air diversion panel, and at the rear of the intercooler.

〈Parts used: 77〉

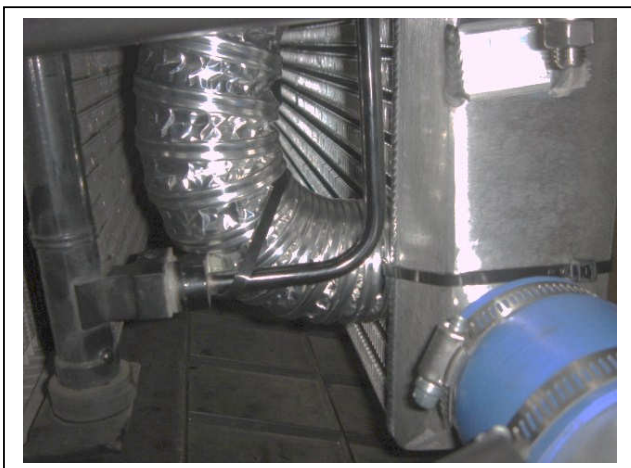
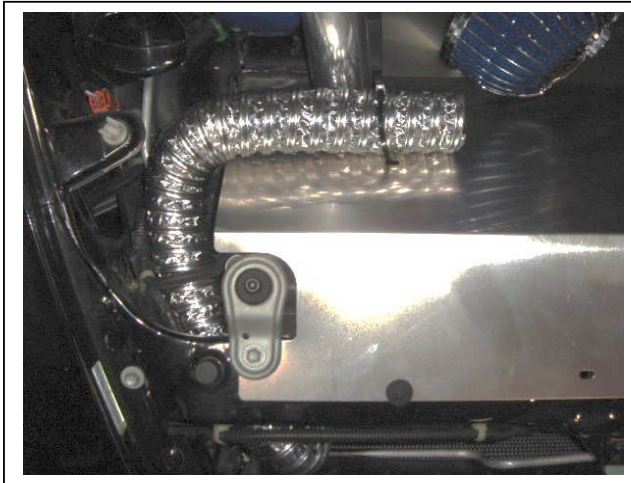
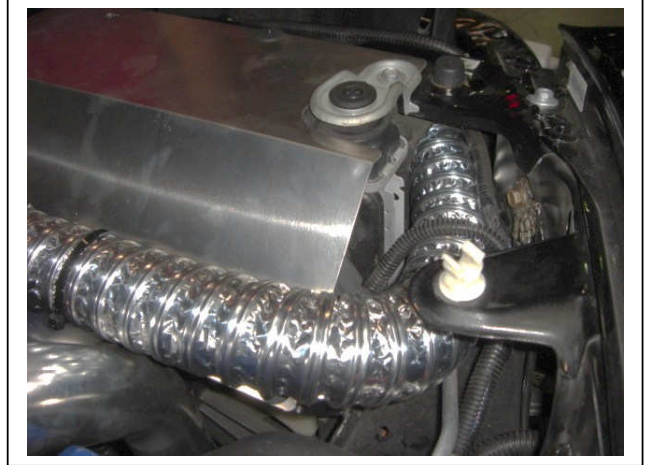

3-17 Bumper and Under-Cover Modification

(1) The factory under-covers and fender liners need to be cut in order to accommodate the intercooler piping. Cut the areas as shown.

Front engine undercover



Rear engine undercover

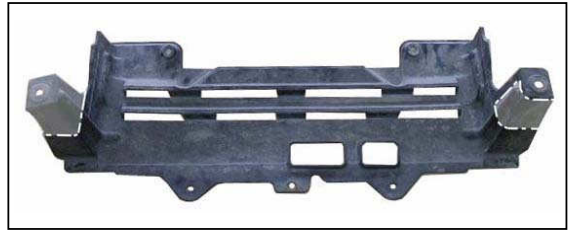

Passenger side fender liner

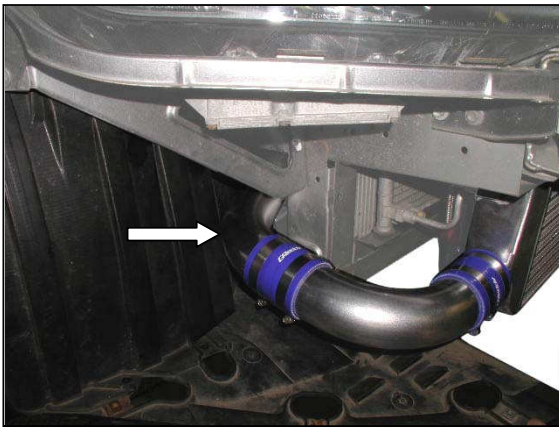

Driver side fender liner



(2) Cut the factory front bumper as shown to accommodate the front mount intercooler.



(3) Cut the front bumper side vents and secure the piping to the bumper. (Optional step)



3-17 e-Manage Ultimate Installation

- (1) Remove the driver side kick panel cover in order to access the ECU and ECU harness.
- (2) Disconnect the ECU harness from the ECU.
- (3) Connect the Emanage Ultimate Plug and Play Harness to the ECU and plug the stock ECU harness into the Ultimate Plug and Play Harness.
(Parts used: 14, 15)
- (4) Keep the Emanage Ultimate unit in a cool, dry place. Try not to cover it with any carpeting, and keep it out of direct sunlight.

3-18 Starting the Engine

- (1) Refill the engine oil to factory spec.
- (2) Check all the hoses and wires connection and reconnect the negative side of the battery.
- (3) Turn the ignition to "ON" position 2-3 times to get fuel pressure. Then, check the injectors and the fuel rail for any fuel leaks.

*** Repair any fuel leaks before starting the engine. Starting the engine with a fuel leak can cause fire in the engine compartment and can be very dangerous.**

- (4) Remove the ECM fuse and crank the engine to get oil pressure to the turbo. (Until the oil light on the dash turns off) Check for any oil leaks, then reinstall the fuse and start the engine.
- (5) While idling, check for any oil, coolant, or air leaks.
- (6) After inspection, reinstall the under cover and other stock parts that was removed.
- (7) On the initial run, be sure to have a boost gauge to check the turbo-actuator setting. This turbo kit is preset to boost between 0.50kg/cm^2 to 0.55kg/cm^2 (7 – 8 PSI).
It is very important that you monitor the boost pressure, and make sure not to over boost. Over boosting can cause engine damage.

This completes the Turbo Kit installation.

Important!

- It is very important that you monitor the boost pressure, and make sure not to over boost. Over boosting can cause engine damage.
- GReddy Performance Products, Inc. is not responsible for any engine damage caused by over boosting (increased boost), modification to the kit, and/or misuse of the product. **NO WARRANTY** is offered.
 - Due to lack of control over proper installation and use of this product, **NO WARRANTY** is offered for this kit.

Emanage Ultimate Information

Important!

- The e-manage included in this kit is preprogrammed for the this turbo kit.
- Do not attempt to adjust any of the setting in the e-manage.
- Any adjustments made can cause damage to the e-manage, engine and the factory ECU.

① **ACTIVE L.E.D.**

- When the ignition is turned on, it will illuminate and flash GREEN.
- When an error is detected it will flash RED.

② **INTERACTION L.E.D.**

- This will flash when there is a connection with PC.

****IMPORTANT NOTE****

For GReddy turbochargers, GReddy Performance Products, Inc. recommends the use of **100% FULLY Synthetic Motor Oil made for turbochargers!** The use of improper oils may cause damage and shorten the life of the turbocharger. GReddy Performance Products, Inc. will not be held responsible for damages due to the use of improper oil.